

Pyxis[®]

GUARDIAN
BOILER FEEDWATER

IK-2000 Series

Water Quality Management Analyzer for Boiler Feedwater

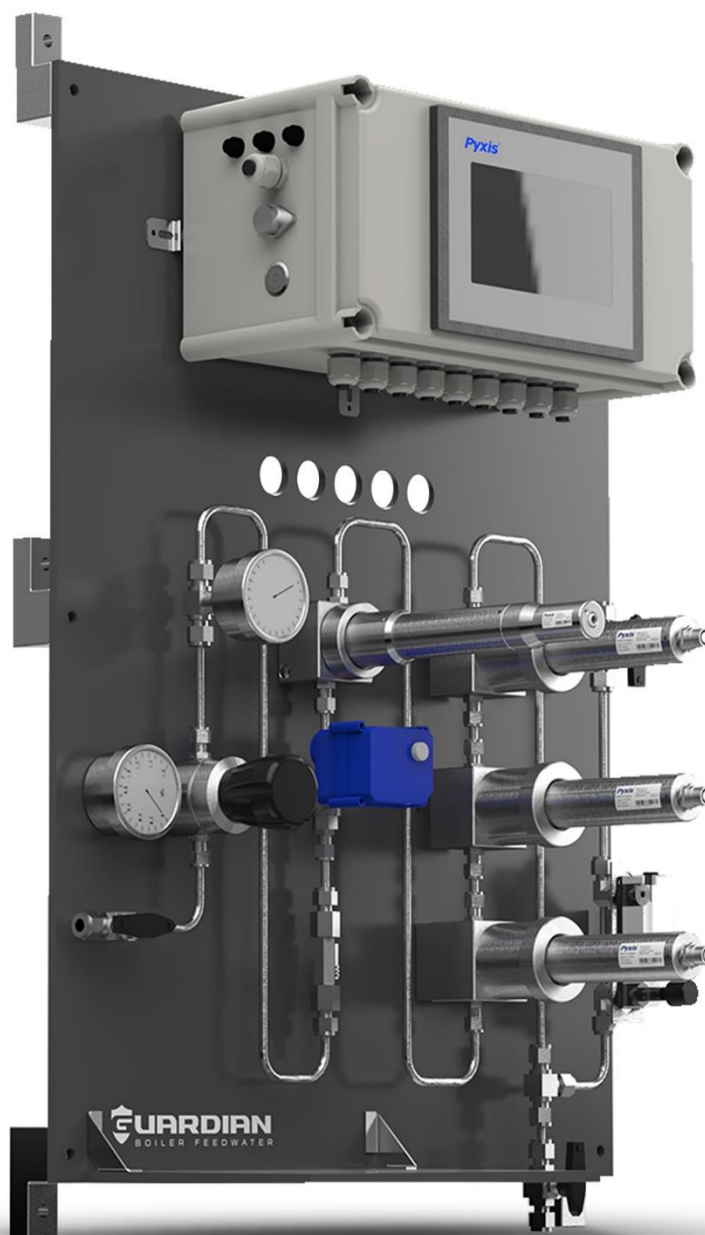

Pyxis Lab[®] Inc.

21242 Spell Circle
Tomball, TX 77375
www.pyxis-lab.com

USER MANUAL

Related Statements

The manufacturer shall not be liable for direct, indirect, special, incidental or consequential damages resulting from any deficiency or omission in this manual. The manufacturer reserves the right to make changes to this manual and the products described in it at any time without notice or liability. Revised versions can be found on the manufacturer's website.

Safety Information

Please read this manual completely before unpacking, installing and operating this equipment. In particular, pay attention to all dangers, warnings and precautions, otherwise, it may cause serious personal injury to the operator or damage to the equipment.

Use of Danger Information

 Danger

Indicates a potentially or urgent dangerous situation that, if not avoided, will cause death or serious injury.

 Warning

Indicates a potentially or very dangerous situation that, if not avoided, may cause serious personal injury or death.

 Warning

Indicates a potentially dangerous situation that may cause a certain degree of personal injury.

Attention

Indicates conditions that if not avoided, will cause damage to the instrument. This is information that needs special emphasis.

Warning Label

Please read all labels and marks attached to the instrument. Failure to follow the instructions on these safety labels may result in personal injury or damage to the instrument.





	If this symbol appears in the instrument, it means refer to the operation and/or safety information in the instruction manual.
	If there is this mark on the instrument housing or insulator, it means there is a risk of electric shock or death from electric shock.
	Static electricity can damage the delicate internal electronic components, resulting in reduced performance or eventual failure of the instrument.
	Electrical equipment marked with this symbol cannot be disposed of through the European public waste system after August 12, 2005. In order to comply with European regional and national regulations (EU Directive 2002 / 98 / EC), European electrical equipment users must now return abandoned or expired equipment to the manufacturer for disposal without any cost.

Table of Contents

Specifications	4
Product Description.....	5
Features.....	5
Sensor Description	6
Pyxis Guardian Hardware & Display Features.....	7
Part Numbers & Ordering Details.....	7
1. Analyzer Dimension and Mounting.....	8
2. Analyzer Installation	12
3. 8.1. Installation Requirements.....	12
4. 8.2. Sample Water Connection.....	12
5. 8.3. UC-100AGS Display Wiring Diagram	13
6. UC-100AGS Display Touch Screen Operation	14
7. 9.1. Main Screen.....	14
8. 9.2. User Login & Password	14
9.3. Real-Time Monitoring.....	15
9.4. Explanation and use of the HOLD Feature	15
9.5. Menu Bar	17
9. 9.6. Configurable Parameters	17
9.6.1. <i>Temperature Control of Sample Flow</i>	18
9.6.2. <i>Output Control</i>	19
9.6.3. <i>User Defined Settings</i>	21
9.6.4. <i>Settings Interface</i>	23
9.6.5. <i>Diagnostic Parameters for Troubleshooting Support</i>	25
9.6.6. <i>4-20mA Output Signal Range Parameter Settings & Adjustment</i>	26
9.6.7. <i>UC-100AGS Modbus Communication Settings</i>	27
9.7. Sensor Calibration.....	27
9.7.1. <i>Dissolved Oxygen (DO) Calibration – ST-774</i>	27
9.7.2. <i>Sulfite (SO₃) Calibration – ST-765SS-SO₃</i>	31
9.7.3. <i>pH Calibration – ST-765SS-SO₃</i>	32
9.7.1. <i>ORP Calibration – ST-765SS-SO₃</i>	34
9.7.2. <i>Fluorescein (Tracer) Calibration – ST-525SS-T</i>	35
9.7.3. <i>Conductivity (TDS) Calibration – ST-724</i>	36
9.8. Alarm View	37
9.9. Historical Data – Query, View & USB Download	37
9.10. Historical Data Curves.....	39
9.11. User Management	41
Modbus Register Table & Analyzer Maintenance	42
10.1. Modbus Correspondence Address.....	42
10.2. Analyzer Operation and Maintenance.....	43
10.3. Instrument Alarms and Descriptions	44
10.4. Replacing ST-765SS-SO ₃ pH, ORP and Sulfite Electrode Head.....	45
10.5. Replacing ST-774 Dissolved Oxygen Cartridge Assembly (DCC-2).....	46
10.10.6. Sensor Cleaning with Pyxis Probe Cleaning Kit	47

Specifications

Item	Guardian IK-2000	Guardian IK-2010	Guardian IK-2020	Guardian IK-2030
P/N	47522	47744	43809	48807
Guardian Boiler Feedwater Analyzer	Level 1	Level 2	Level 3	Level 4
Dissolved Oxygen Measure Range	0.1 - 2,000 ppb / ±0.3ppb			
Dissolved Oxygen Method	Optical - Blue Light Irradiated Excitation / Red Light Reference			
Temperature Measure Range	0 °C – 50 °C (32 - 122° F) / ± 0.2% of value – Taken from ST-774			
Sulfite Measure Range	*NA*	0.00 – 100.00 ppm / ± 0.01ppm		
Sulfite Method	*NA*	Bare Gold – Electrochemical Method		
pH Range	*NA*	0.01 – 14.00 pH / ± 0.01pH		
ORP Range	*NA*	-1,500 to 1,500mV / ±1mV		
Fluorescein Range	*NA*	*NA*	0.0 – 60.0 ppb / ±0.2ppb	
Fluorescein Method	*NA*	*NA*	Optical 470 Ex / 520 Em	
Conductivity Range	*NA*	*NA*	*NA*	0.02 – 1,000 uS/cm
Conductivity Method	*NA*	*NA*	*NA*	Hastelloy 2-Electrode
Conductivity Cell Constant (K)	*NA*	*NA*	*NA*	0.3
Measurement Interval	Continuous Measurement w/4 Second Delay			
UC-100 AGS Display	7-inch LCD Color Industrial Capacitive Touch Screen			
UC-100AGS Storage Capacity	Built-In 4GB of Ram for Storing up to 1-Million Data/Event Records			
UC-100AGS Output	6 x 4-20 mA / RS-485 Modbus - RTU / Modbus TCP			
UC-100AGS Input	RS-485 Modbus - RTU			
UC-100AGS Relay Control	2 x 24VDC Relay Controls			
UC-100AGS Analog Control	2 x Analog Controls			
UC-100AGS USB	1 x USB host, for data downloading and screen upgrade			
UC-100AGS Internet	RJ-45 socket, Modbus-TCP, Embedded CloudLink™ 4G Gateway with Global SIM			
UC-100AGS Relative Humidity	20% - 90% (No Condensation)			
Panel Power Requirement	96-260VAC / 75 W – USA Type B Plug			
Panel Dimension (H x W x D)	Panel 600H x 800W x 335D mm			
Panel Approximate Weight	Panel ~ 25 kg			
Panel Operational Temperature	40 – 120°F (4-49 °C)			
Panel Storage Temperature	Instrument: -4 – 131°F (-20 – 55°C) / Sensors 32 – 122°F (0 – 50°C)			
Panel Wet Material	Hastelloy/304SS/316SS/Glass/Gold/Platinum/CPVC/PTFEPOM/ABS/PEEK/PET/NBR/PCB			
Sample Water Temperature†	40 – 120°F (4-49°C) †			
Sample Water Pressure	7.25 – 30 psi (0.05 – 0.2Mpa) Inlet / Atmospheric Drain Outlet			
Sample Water Flow Rate	100 - 500mL / Minute			
Sample Line Size	¼-inch OD Stainless Steel Tubing with Swagelok Compression Inlet & Outlet			
Rating	IP-65 Panel-Display / IP-67 Sensors			
Regulation	CE / RoHS / UKCA			
Sensor Warranty (All)	13 Months			
ST-765SS-SO3 Electrode Warranty	6 Months			
ST-765SS-SO3 Replacement Electrode Service Life	12-24 Months Depending on Water Quality			

Specifications are subject to change without notice.

NA = Sensors not included but may be later purchased & field installed if desired by user

CloudLink 4G Gateway & SIM Card Activated Upon Annual Enrollment

† Requires Installation Downstream of Sample Cooler

Product Description

The Guardian IK-2000 series are multi-parameter inline water quality analyzers specifically designed as a 'Turn-Key' monitoring solution for boiler feedwater and chemical treatment applications ranging from low to high pressure operations. The Guardian boiler feedwater series is offered in "ONE-PANEL" design, with a variety of Pyxis Lab smart sensor options based on the application and need. This format allows the user the flexibility to begin with a base model and add sensor capability over time and as desired, without the need to replace or configure anything. Simply plug in the new sensor to the available sensor pigtail on the analyzer, and the Guardian will automatically recognize, configure, and initiate operation, calibration interface and data logging of the added sensor. With all sensor options installed, the Guardian boiler feedwater series offers highly accurate and repeatable, real-time measurement, display, and data-logging of sample water Dissolved Oxygen (ppb), Temperature (°C/°F), pH, ORP (mV), Sulfite (ppm), Conductivity (µS/cm), Total Dissolved Solids (ppm) and Sample Flow Rate (mL/Min) utilizing proprietary Pyxis Lab smart sensor technology coupled with a Pyxis color touch screen display and data logging terminal.



Guardian Boiler Feedwater IK-2000 Series

The Guardian boiler feedwater series should always be installed downstream of a sample cooler and are offered in a convenient and easy to integrate panel mounted format using only 304 and 316L stainless steel with SwageLok™ compression fittings to ensure optimum sensor performance and longevity. With an integrated shelf for easy sensor calibration and maintenance, the Guardian Boiler Feedwater Series was designed with the user in mind.

The Guardian IK-2000 series boiler feedwater analyzer integrates up to four (4) unique Pyxis smart sensors.

NOTE The base model will come equipped with one ST-774 sensor only and all remaining pre-plumbed stainless tee assemblies are plugged for future use as the user desires.

Features

- Fully Integrated & Turn-Key Boiler Feedwater Analyzer
- UC-100AGS (7-inch) Color-Touch Screen Display & Data Logging Terminal
- Pre-Configured Firmware to Enable up to 4 Pyxis Smart Sensors
- Pre-installed CloudLink™4G Wireless Gateway with Global SIM Card – Activated Upon User Enrollment
- 3. • Pre-plumbed in fully stainless steel ¼-inch tubing with compression fittings
- Integrated Digital Sample Flow Meter and Manual Rotameter
- Integrated ST-774 Ultralow Dissolved Oxygen Sensor with Flow Cell
- Integrate stainless steel solenoid isolation valve for sample lockout on temperature alarm
- Three (3) Integrated ST-007 stainless steel inline Tee assemblies for up to 3 more Pyxis sensors
- Plug-N-Play sensor installation with pre-wired pigtails for future sensor addition.
- Integrated Sensor Calibration & Maintenance Shelf for user convenience

Sensor Description

ST-774: Provided on all versions of the Guardian, the ST-774 is an ultra-low range dissolved oxygen (DO) sensor with a lower limit of detection 0.1 ppb ($\mu\text{g/L}$). Its design is based on the principle of fluorescence quenching to determine the partial pressure of the dissolved oxygen in water and incorporates Pyxis' advanced technology in the field of fluorescence detection. The Pyxis ST-774 offers the robustness associated with optical DO sensor technology while achieving the ultra-low detection limit comparable to an amperometric DO sensor. The ST-774 measures the oxygen partial pressure that is at equilibrium with the dissolved oxygen in water governed by Henry's law ($DO/ppb = K PO_2$). The ST-774 offers an easily replaceable, front loading DO membrane cartridge (DCC-2) that has been independently developed by Pyxis Lab, with a typical service life of up to 2-years. This sensor is also well known in the industry for its ability to be Zero-Calibrated in the field using the Pyxis Sulfite-ZERO calibration kit and the connected display terminal. The flat front-end design of the ST-774 makes this platform less prone to contamination or fouling and is very easy to clean. The sensor body and flow cell are composed of 316L stainless steel and is well suited for aggressive industrial application use.

ST-765SS-SO3: This sensor is provided with the Level 2 through 4 versions of the Guardian along with the ST-774, or as an add-on sensor in the field. The ST-765SS-SO3 is a stainless-steel multi-parameter membrane-less sensor based on unique electrochemical principles to determine sulfite, pH, ORP and temperature of sample water. This sensor incorporates Pyxis' advanced technology in the field of bare-gold electrochemical detection. The ST-765SS-SO3 can simultaneously compensate for temperature and pH in the measurement of sulfite based on real-time conditions present in the application of use. This unique internal compensation results in a highly accurate sulfite measurement consistent with wet chemistry methodology commonly used for measurement of oxygen scavengers. This sensor may be calibrated while in service to the tested feedwater sulfite residual using a standard field drop test titration and the connected display/data logging terminal. The ST-765SS-SO3 sensor also offers a replaceable, front loading reference electrode assembly (EH-765) that has been independently developed by Pyxis Lab eliminating the shortcomings associated with membranes and gel replacement while offering reduced polarization time on startup with an electrode life span potential of up to 2-years. The ST-765SS-SO3 sensor body is composed of 304 stainless steel and is well suited for aggressive environments. This sensor is installed in one of the available stainless-steel ST-007 flow cells on the Guardian analyzer panel.

ST-525SS-T: This sensor is provided with the Level 3 and 4 versions of the Guardian along with the ST-774 and ST-765SS-SO3, or as an add-on sensor in the field. The ST-525SS-T is a newly designed stainless steel drop-in version of the well-known ST-525 inline fluorometer platform for the direct measurement of Fluorescein tracer utilizing LED light sources for use in industrial boiler feedwater. The new physical design of this sensor allows simple insertion into the stainless-steel ST-007 flow cell enabling easy sensor removal for cleaning and calibration. This sensor offers proprietary algorithms to determine the concentrations of Fluorescein at levels as high as 60ppb and resolution of 0.1ppb, while simultaneously measuring light loss through the optical channel to determine sensor cleanliness. After cleanliness has been verified, this sensor may be slope calibrated using Pyxis Fluorescein calibration standard solutions and the connected display terminal.

ST-724: This sensor is provided with the Level 4 version of the Guardian, along with ST-774, ST-765SS-SO3 and ST-525SS-T, or as an add-on sensor in the field. The ST-724 provides a unique electrode design using a Hastelloy liquid end with integrated temperature and RTD compensation offering precision accuracy in ultra-low to low range conductivity waters with a range of detection from 0.02 to 1,000 $\mu\text{S/cm}$. User conversion programming for display as TDS (Total Dissolved Solids) is also fully integrated into the Guardian boiler feedwater series display interface. The addition of ST-724 to the Guardian analyzer makes boiler cycles of concentration a measurable value when used with an existing boiler blowdown controller.

Pyxis Guardian Hardware & Display Features

- The Guardian boiler feedwater series comes equipped with three (3) pre-mounted ST-007 Single-Sensor inline stainless steel flow cells as well as (1) ST-774 flow stainless steel flow cell. The sample plumbing is 316L stainless steel with SwageLok fittings in ¼-inch OD compression. The Guardian analyzer is also equipped with inline rotameter (100-500ml/min), solenoid sample temperature lockout valve and digital Hall-Effect inlet flow meter for precise sample flow measurement and control recommended at 100-500 mL/minute with a maximum inlet pressure suggested of 30psig. The outlet flow should be diverted to drain or the inlet of the pretreatment system for those desiring recovery (i.e. condensate return tank).

IMPORTANT NOTE The Pyxis Guardian requires installation downstream of an inline sample cooler with sample effluent to atmospheric drain or lower pressure zone of feedwater storage. Sample water temperatures should be maintained at or below 120°F (49°C) and pressure at or below 30psig.

- All Pyxis sensors are connected to the UC-100AGS color touch screen (7-inch) display and data logging terminal via RS-485 Modbus (RTU) allowing for integrated sensor calibration interface, diagnostics, data alarming, log, trending and transfer within the display touch screen. The display comes prewired with a total of four pre-labeled 8-pin flying lead wires with quick-adapter allowing users to easily connect the Pyxis sensor to the input cable for immediate sensor recognition, display and use. The display/data logger offers 6 x 4-20mA outputs as well as Modbus RS-485 and TCP-IP with remote diagnosis and parameter adjustment. The display comes equipped with two 24VDC relay controls (Passive) and two Analog output controls which can be user defined and programmed based on rising or falling setpoint of any sensor value or as a timed event.
- Each Guardian boiler feedwater analyzer comes equipped with the Pyxis CloudLink™ 4G Gateway and global SIM Card in deactivated mode. This gateway may be activated by Pyxis Lab upon user request and annual enrollment, allowing for wireless data transmission to any cloud data management platform, including Pyxis Cloud™. Contact service@pyxis-lab.com for more information.
- Convenient and simple to install back-panel with integrated sensor calibration & maintenance shelf for rapid installation and convenience of use. Truly a plumb and power to go platform with intense factory setup, testing and sensor calibration prior to shipment.

Pyxis Guardian Versions (Sensors Included)

Item	Guardian IK-2000 (Level 1)	Guardian IK-2010 (Level 2)	Guardian IK-2020 (Level 3)	Guardian IK-2030 (Level 4)
P/N	47522	47744	43809	48807
ST-774 (Dissolved Oxygen + Temperature)	Included	Included	Included	Included
ST-765SS-SO3 (Sulfite + pH + ORP)	Add Later If Desired	Included	Included	Included
ST-525SS-T (Fluorescein Tracer)	Add Later If Desired	Add Later If Desired	Included	Included
ST-724 (Conductivity + TDS)	Add Later If Desired	Add Later If Desired	Add Later If Desired	Included

NOTE The Guardian Boiler Feedwater Analyzer panel design is identical for all 4 levels allowing users to purchase the base level 1 and later purchase and install as desired the additional Pyxis sensors without the need for equipment upgrade, configuration or replacement.

Part Numbers & Ordering Details

Order Information

	P/N
Guardian Boiler Feedwater IK-2000 <i>(Integrated Analyzer with Flow + DO + Temperature + 3-Unused ST-007 Flow Cells)</i>	47522
Guardian Boiler Feedwater IK-2010 <i>(Integrated Analyzer with Flow + DO + SO₃ + pH + ORP + Temperature + 2-Unused ST-007 Flow Cells)</i>	47744
Guardian Boiler Feedwater IK-2020 <i>(Integrated Analyzer with Flow + DO + SO₃ + pH + ORP + Temperature + Fluorescein + 1-Unused ST-007 Flow Cell)</i>	43809
Guardian Boiler Feedwater IK-2030 <i>(Integrated Analyzer with Flow + DO + SO₃ + pH + ORP + Temperature + Fluorescein + Conductivity)</i>	48807

Optional / Replacement Accessories Information

	P/N
ST-774 <i>(Ultra-Low Luminescent Dissolved Oxygen + Temp. Sensor 0.1-2,000ppb – Stainless Steel)</i>	53715
ST-774 SERVICE SWAP <i>(Annual swap out of ST-774 for Pyxis Factory Serviced & Calibrated Unit)</i>	ST-774-SWAP
ST-765SS-SO ₃ <i>(Sulfite + pH + ORP Sensor w/Internal Compensation 0-100ppm – Stainless Steel)</i>	53624
ST-525SS-T <i>(Fluorescein Sensor w/Internal Compensation 0-60ppb – Stainless Steel)</i>	56553
ST-724 <i>(Ultra-Low Conductivity + Temp. Sensor 0.02 – 1,000 μS/cm – Stainless Steel)</i>	10009
DCC-2 <i>(Replacement Luminescent Cartridge Cap for ST-774)</i>	53716
EH-765 <i>(Replacement Electrode Head for ST-765SS-SO₃)</i>	53061
Solenoid Valve <i>(Stainless Steel Electric Sample Temperature Isolation Valve – ¼-inch Compression)</i>	21452
Stainless Steel Hall Effect Flow Meter <i>(Pulse Flow Meter ¼-inch Compression 0.1 - 2.5L/Min)</i>	22501
Micro-Rotameter Assembly Kit <i>(Replacement Rotameter Assembly Kit 100-500ml/min)</i>	24387
ST-774 Flow Cell <i>(Replacement Stainless Steel Flow Cell for ST-774 ¼-inch Compression)</i>	53718
ST-007 <i>(Replacement Stainless Steel Flow Cell for ST-765SS-SO₃ / ST-525SS-T / ST-724 Sensors)</i>	50700-A51
Replacement Temperature Gauge	29098
Replacement Pressure Regulating Valve with Gauge	27439
ST-002-S Stainless Steel PLUG <i>(Replacement Plug for Unused Flow Cells)</i>	21629
Sulfite-ZERO Calibration Kit <i>(Sensor Cap & Catalyzed Sulfite w/Vial for ST-774 Zero Calibration)</i>	16019
Pyxis Sulfite Dropper Kit <i>(Sulfite Dropper Titration Kit for ST-765SS-SO₃ Calibration)</i>	TK35290-Z
Pyxis pH Combo Calibration Pack <i>(pH 4-7-10 Calibration Solution 3-Pack - 500mL ea.)</i>	57007
Pyxis ORP-200 <i>(ORP-200mV Calibration Solution – 500mL ea.)</i>	57020
Pyxis FLUO-10 <i>(Fluorescein Calibration Solution – 10ppb – 500mL ea.)</i>	FLUO-10
Pyxis FLUO-20 <i>(Fluorescein Calibration Solution – 20ppb – 500mL ea.)</i>	FLUO-20
Pyxis Conductivity Calibration Std – 100 μS/cm <i>(500mL)</i>	39047
Pyxis Conductivity Calibration Std – 1,000 μS/cm <i>(500mL)</i>	57008

Analyzer Dimension and Mounting

Level 1 - Guardian Boiler Feedwater IK-2000 Dimensions (mm)

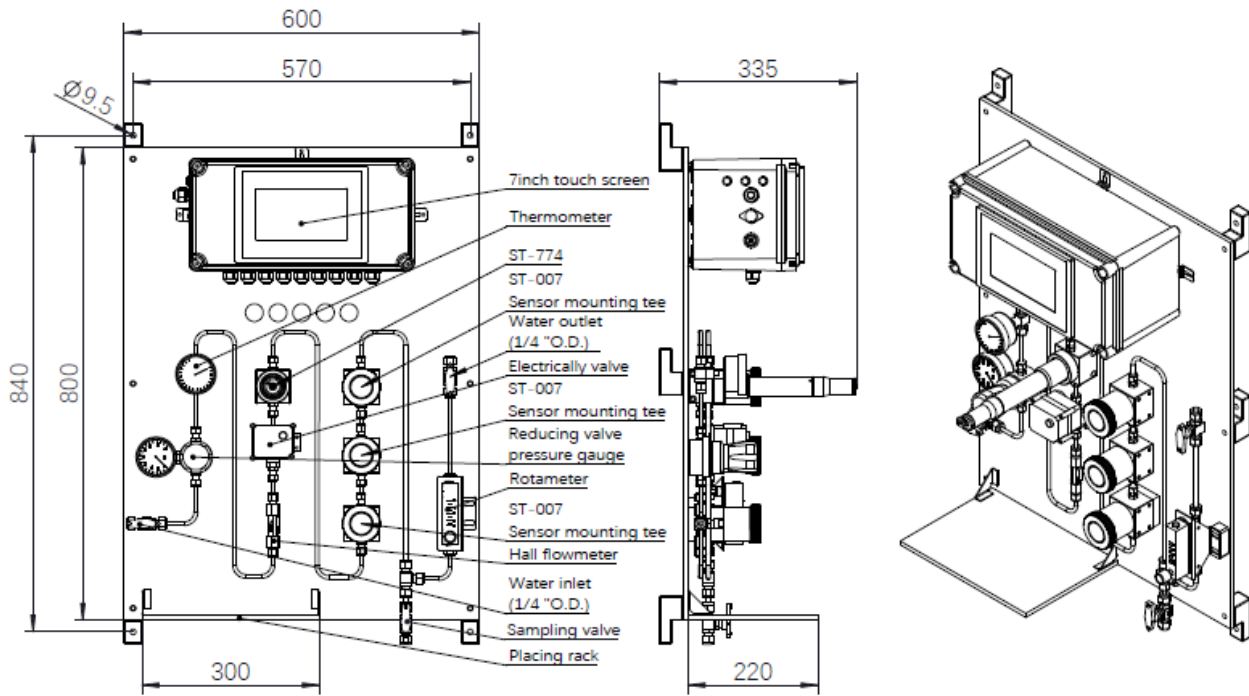

Level 2 - Guardian Boiler Feedwater IK-2010 Dimensions (mm)

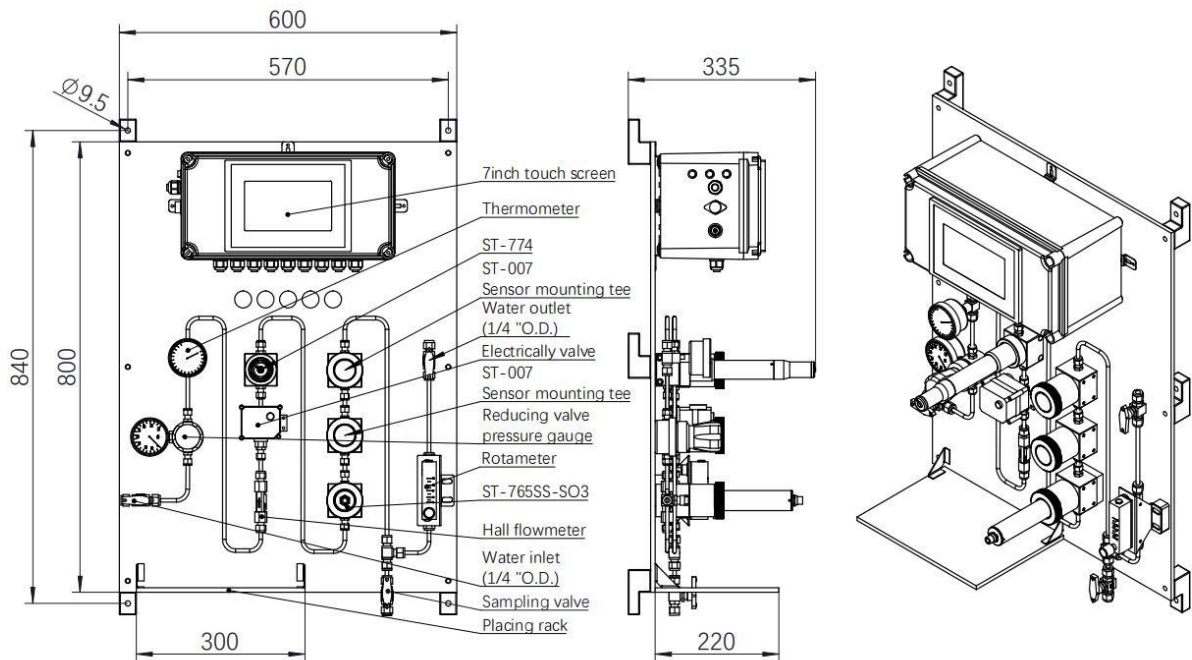

Level 3 - Guardian Boiler Feedwater IK-2020 Dimensions (mm)

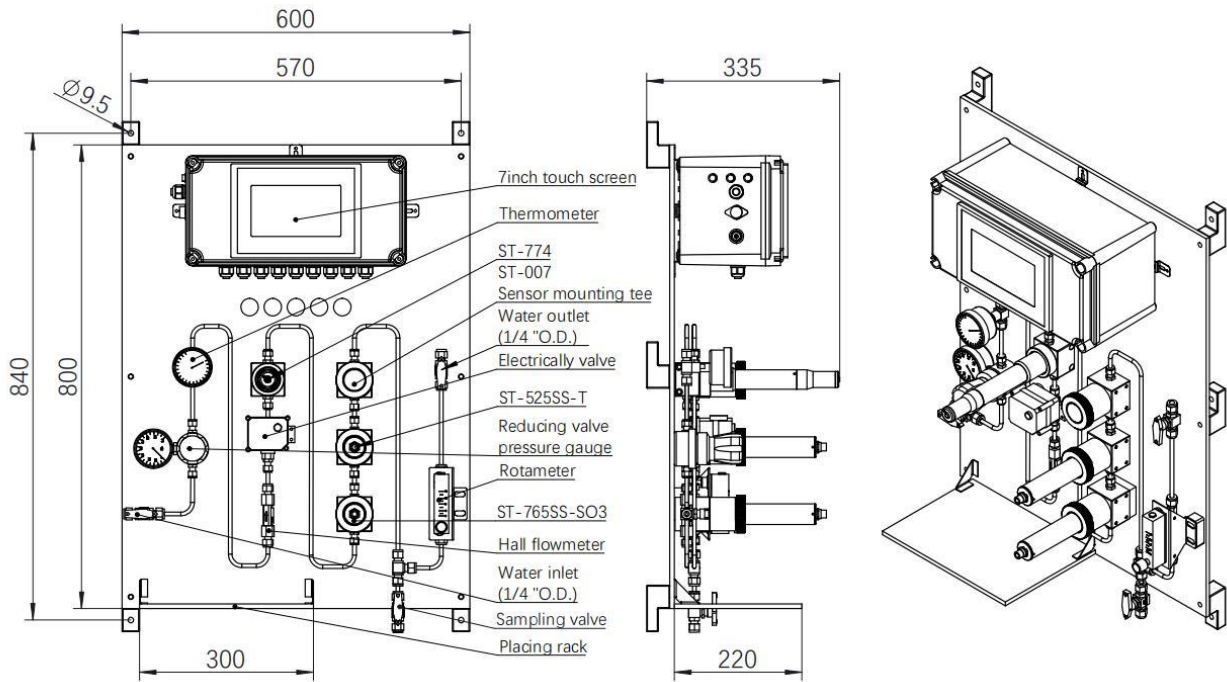

Level 4 - Guardian Boiler Feedwater IK-2030 Dimensions (mm)

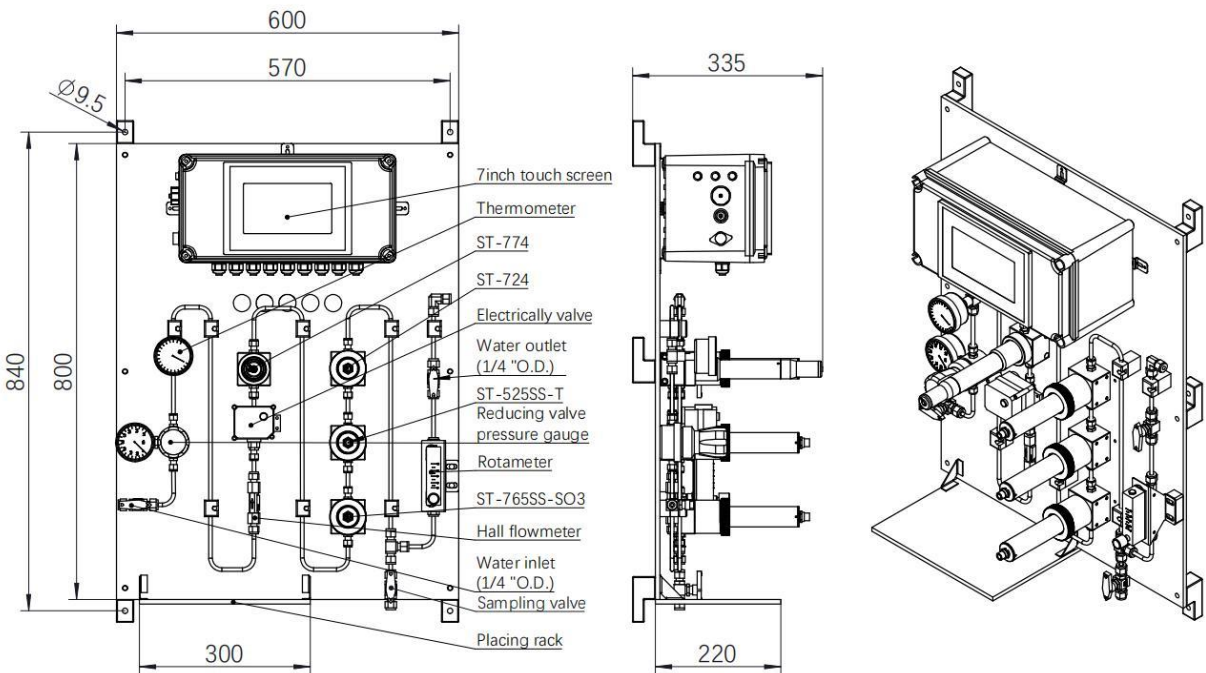

UC-100AGS Display/Data Logger Dimensions (mm)

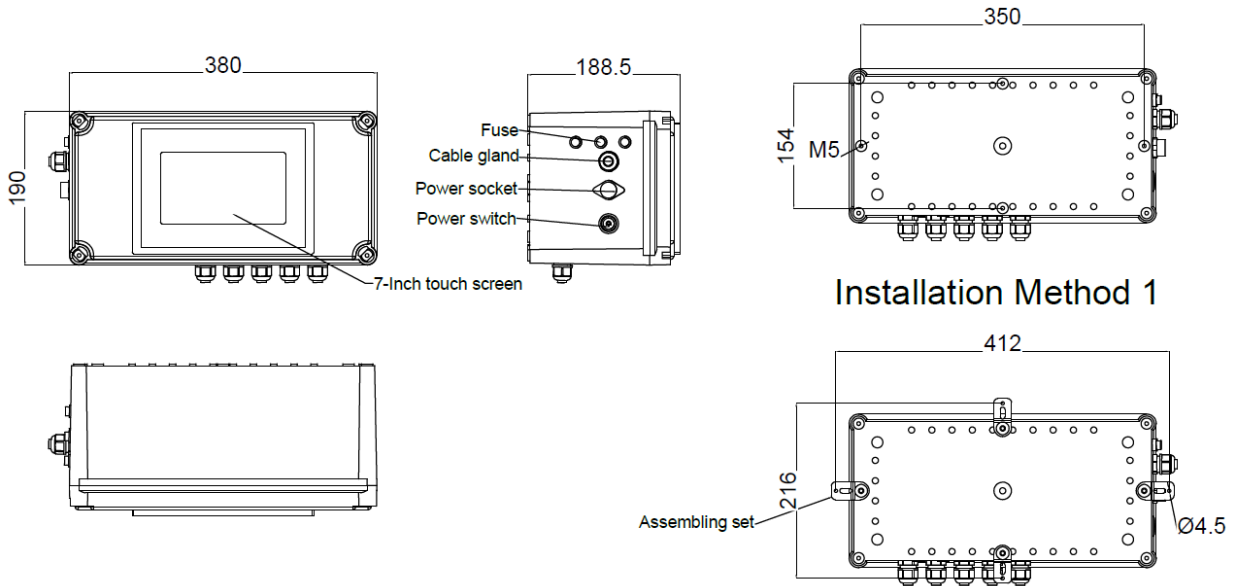

ST-774 Sensor Diagram (mm)

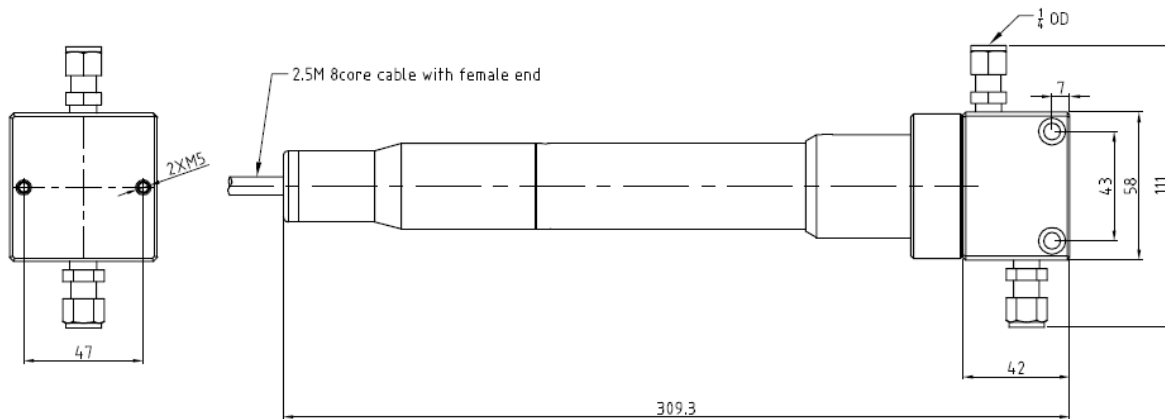

ST-765SS-SO3 Sensor Diagram (mm)

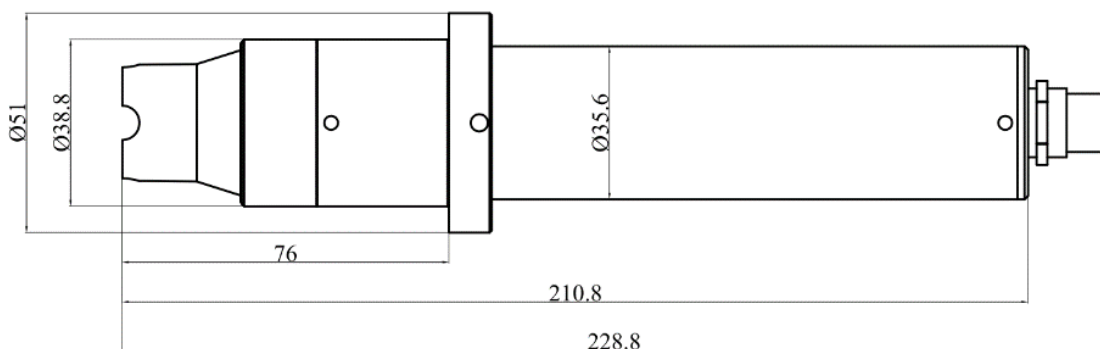

ST-525SS-T Sensor Diagram (mm)

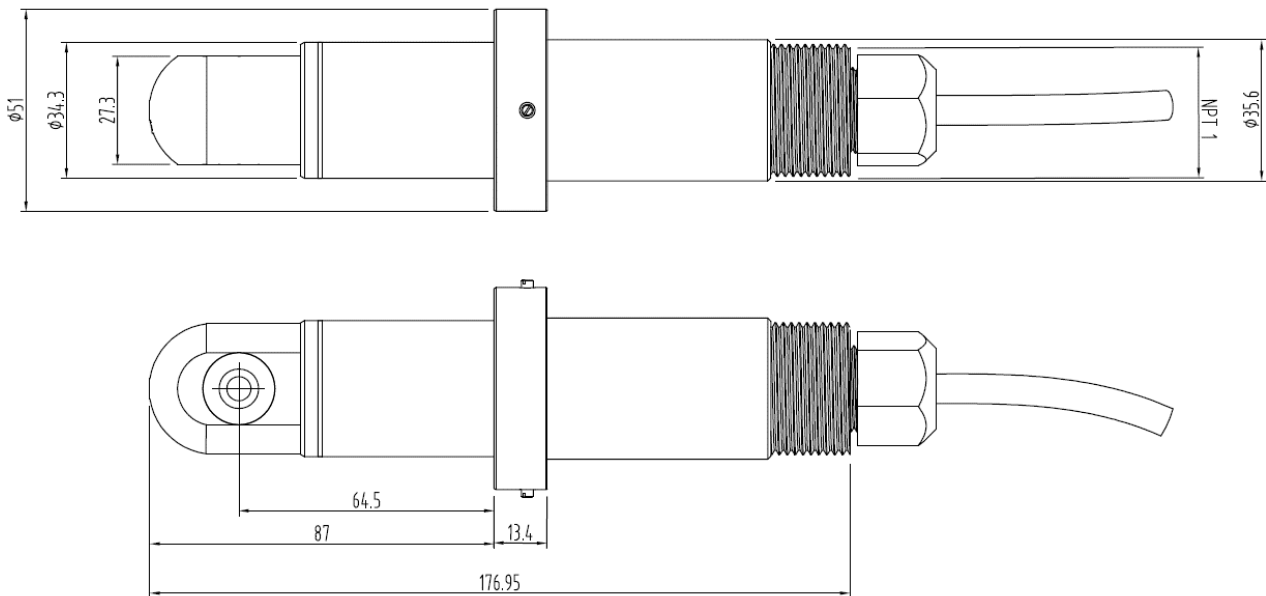

ST-724 Sensor Diagram (mm)

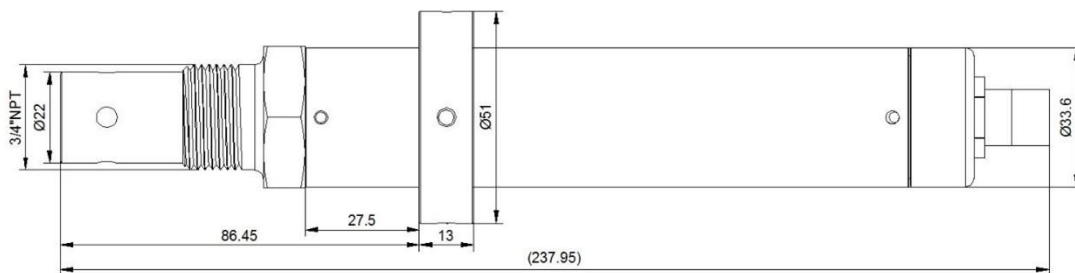

ST-007 Stainless Steel Tee Assembly Diagram

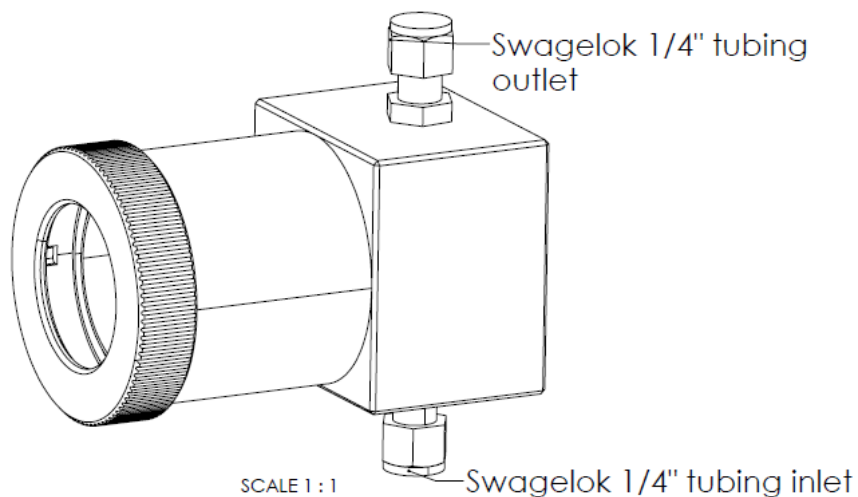

SCALE 1 : 1

Analyzer Installation

8.1. Installation Requirements

Power Supply: 96-260VAC / 50-60 Hz; 75 W

Inlet Water Supply: The inlet water pressure should be from 7.25 – 30 psi (0.05 – 0.2Mpa) 8.

Outlet Water Line: This line should be returned to atmospheric sump or lower pressure recirculation line of the analyzed system water network.

Wall Mount Space: Please leave at least 0.5m of installation space around the equipment for later maintenance.

Wall Mount Weight: Approximately 25kg. Please use appropriate mounting hardware.

8.2. Sample Water Connection

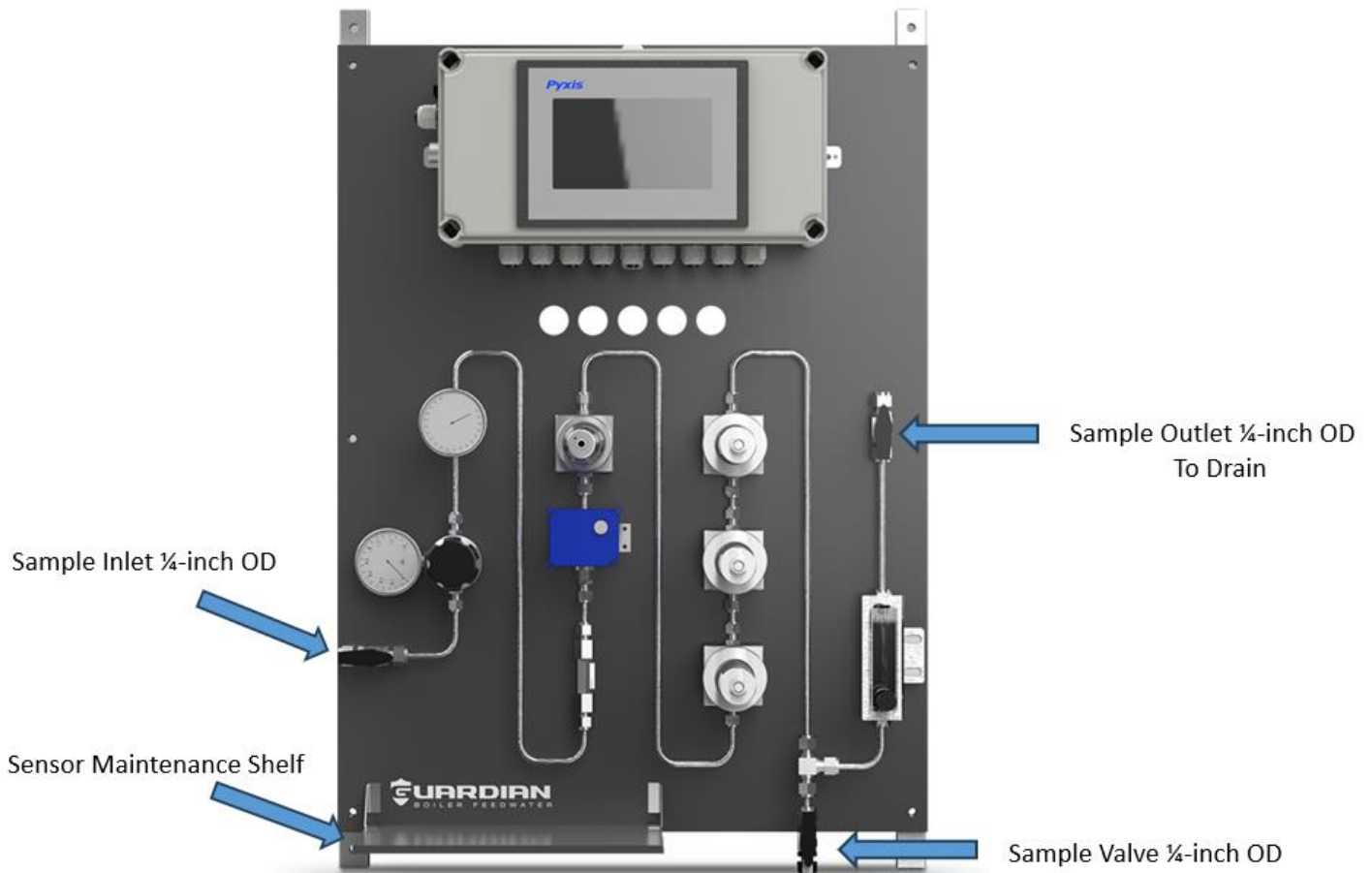

8.3. UC-100AGS Display Wiring Diagram

The IK-2000 series has universal AC power supply equipment allowing users simply to plug the power supply into a 96-260V AC 50/60Hz power outlet for normal operation.

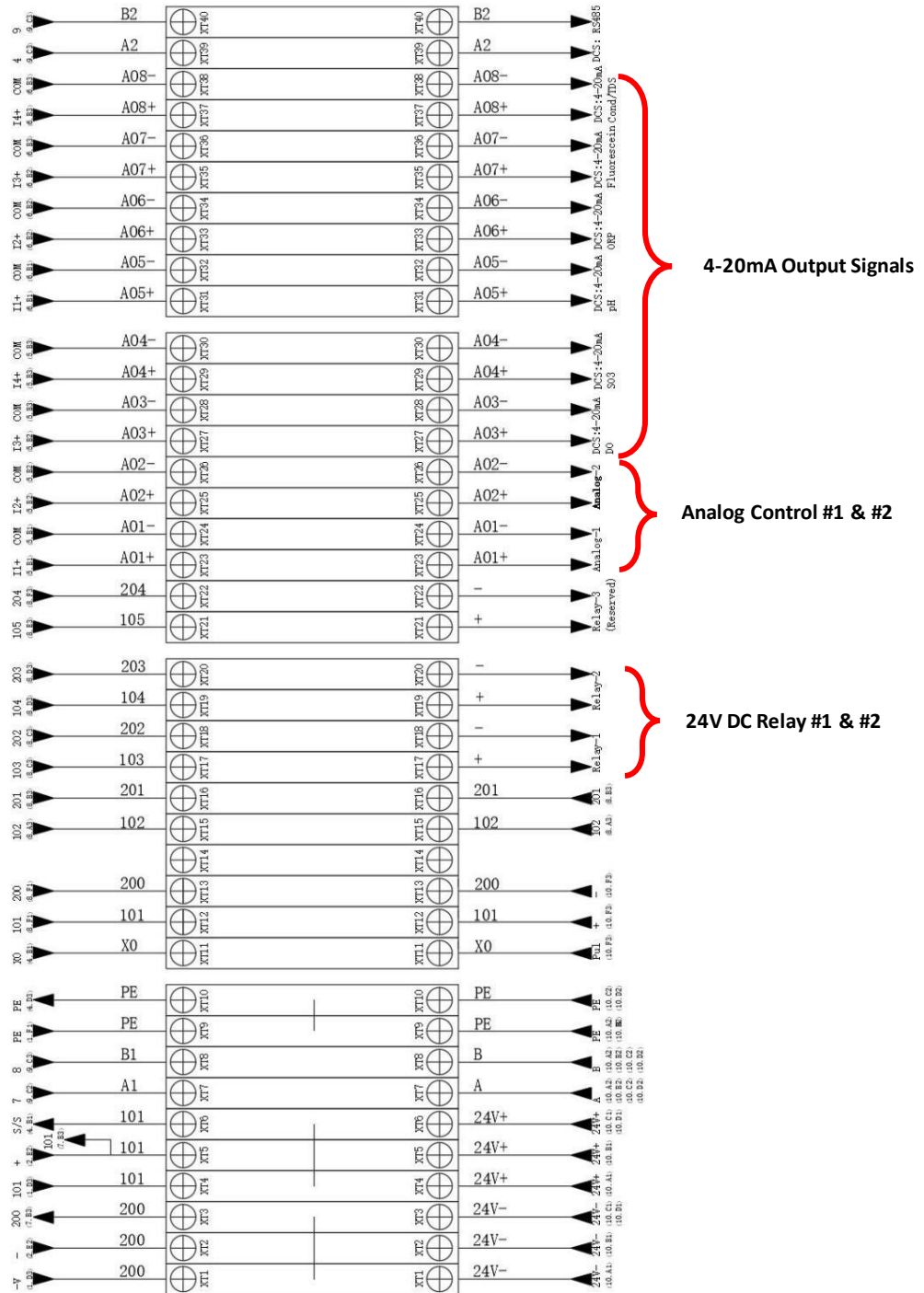

Figure. 1 - Terminal Wiring Diagram

WARNING - The process of electrical connection to contact the 96-260VAC single-phase power supply, should be operated by personnel with an electrician's license. Failure to operate according to the electrical code of practice may result in electric shock injury or even death.

UC-100AGS Display Touch Screen Operation

9.1. Main Screen

After the system is powered on an initial screen allows the user to log into the system.

9.



Figure. 2 - Main Screen

9.2. User Login & Password

After powering on the system, log in with the user name and password to be able to change system settings. Click the "User Login" button, select the user "pyxis", enter the password: "888888" in the user password field. A new user can be added via "User Management" in interface of the menu.

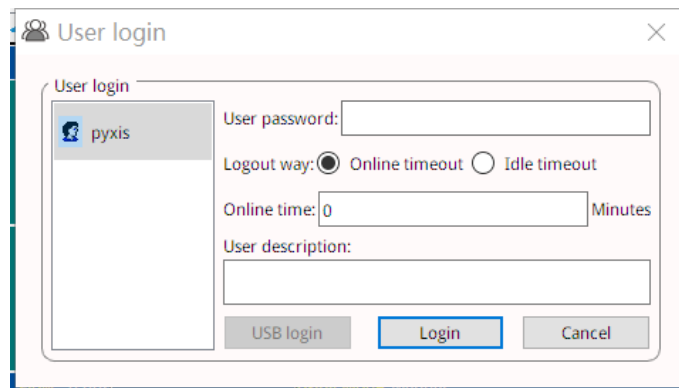

Figure. 3 - User Login Screen

If you do not need a password, or want to change the user, you can enter the system and manage in the "User Management" screen of the menu

9.3. Real-Time Monitoring

Click the "Enter System" button on the main interface to enter the real-time monitoring screen of the system. The data detected by the Pyxis sensors will be displayed in real-time. See a functional overview of each section of this screen highlighted below.

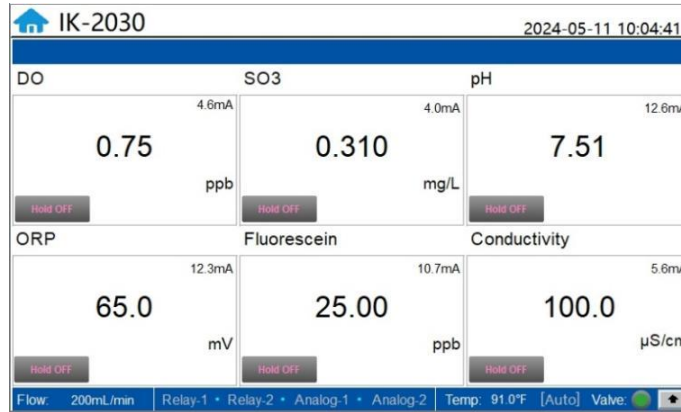

Figure. 4 - Real-time Monitoring Screen

9.4. Explanation and use of the HOLD Feature

The IK-2000 has an integrated HOLD feature for all output parameters from the sensor that would be connected to an onsite DCS network. The purpose for this feature is to allow the user to enter a signal value HOLD on the designated parameter during periods of sensor maintenance or removal. This feature prevents network system alarms from operational shutdown during sensor maintenance or replacement. Click the "Hold OFF" button on the main interface to enter the HOLD setting interface.

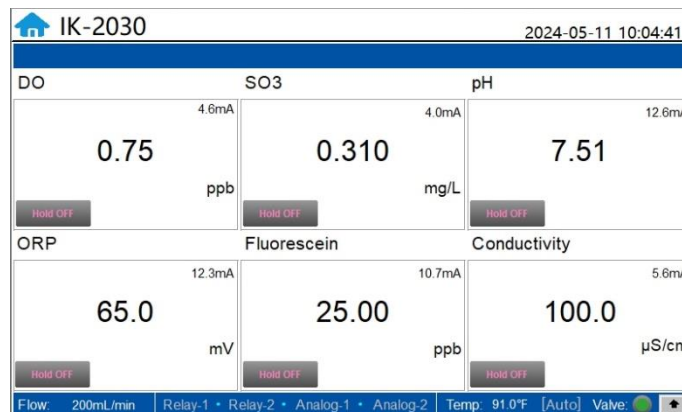

Figure. 5 - Main Interface

In the pop-up box, enter the parameter value and click "Confirm" to open the "Hold ON" function. The main interface will display the entered value for 15 minutes, after which it will resume displaying the real-time value read by the sensor.

When the "Hold ON" function is activated by the user, the sensor may be maintained, calibrated or removed and the Modbus TCP output will continue to retain the user entered value for a period of 15 minutes, ensuring network alarm and process will not be interrupted due to the sudden disappearance of the 'normal' value. The 'actual' live sensor reading along with the user entered hold value reading will both be displayed during this period. Clicking "Cancel" will turn off this function, the main interface will immediately display the real-time value read by the sensor, and the main interface button will be displayed as "Hold OFF".

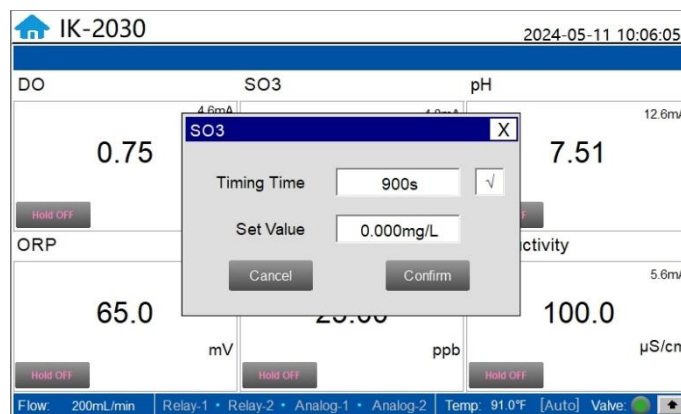

Figure. 6 - Hold Feature Settings

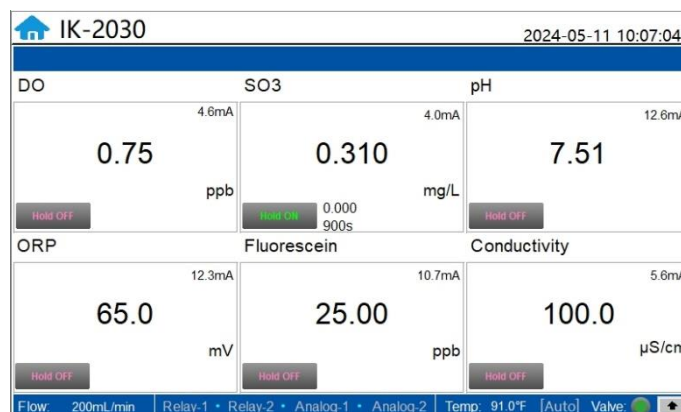



Figure. 7 - Hold ON Interface

9.5. Menu Bar

Click the  button in the upper left corner of the screen to enter the system's menu interface, where the user can select to enter the desired operation interface.

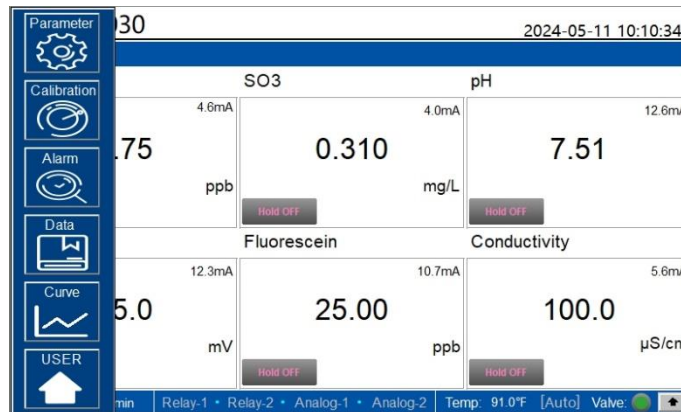

Figure. 8 - Menu Bar

9.6. Configurable Parameters

Click the "Parameter" button in the menu bar. Here you can select a list of options to include enter **Control Interface / User Defined Settings / Settings Interface / Diagnostic Parameters / 4-20mA Output Setup** and **Comm Setup**.



Figure. 9 - Parameter Settings Menu

9.6.1. Temperature Control of Sample Flow

Pyxis recommends always installing the Guardian down stream of a sample cooler not to exceed 120°F for sample water temperature to the inline sensors. The Guardian IK-2000 series offers sample temperature measurement and isolation control based on the inline RTD temperature sensor of the ST-774 (DO + Temperature Sensor). When the measured sample water temperature is greater than the user programmed **alarm temperature setpoint value**, the Guardian UC-100AGS display will close the motorized valve stopping sample flow to the sensors to prevent damage . When the measured sample temperature is less than the user programmed **recovery temperature setpoint value**, the Guardian UC-100AGS display will open the motorized valve and allow sample flow to the sensors once again. ****IMPORTANT NOTE**** *The motorized valve position will be GREEN ● when open and RED ● when closed displayed in the lower right corner of the display screen. When the motorized valve is in the closed position, it UC-100AGS will display the last measured temperature value in the lower right corner of the screen.*

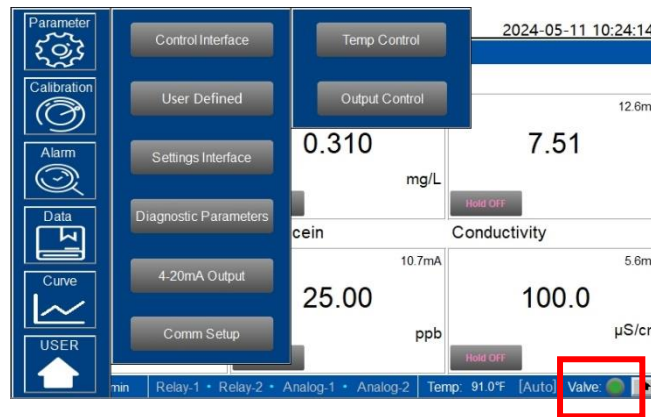

Figure. 10 – Temperature Control Interface

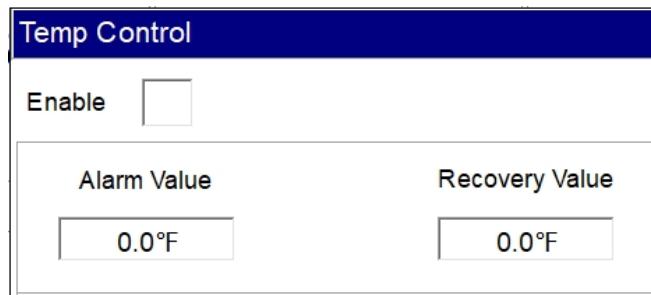

Figure. 11 – Temperature Control Settings

9.6.2. Output Control

The IK-2000 series have two (2) 24VDC Passive (Contact) Relay Controls and two (2) Analog (4-20mA) Controls to be used as desired.

Each control has 4 modes of operation including **Disable / Manual / Periodicity** and **Sensor Value**

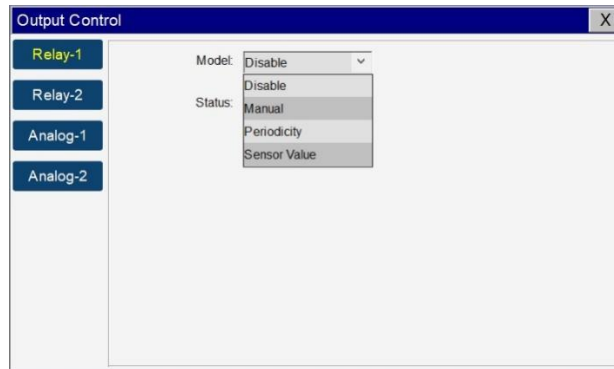

Figure. 12 – Relay Output Control

When the mode selection is set to **Disable**, there will be no relay output available.

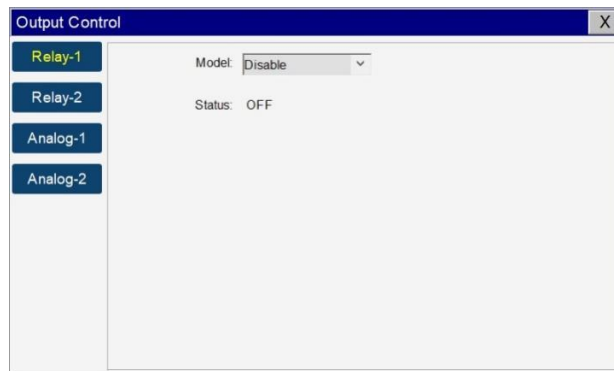

Figure. 13 – Disable

When the mode is selected as **Manual**, users can manually turn on the Output by clicking the "Turn On" button in the lower right corner and turn it off by clicking the "Turn On" button again.

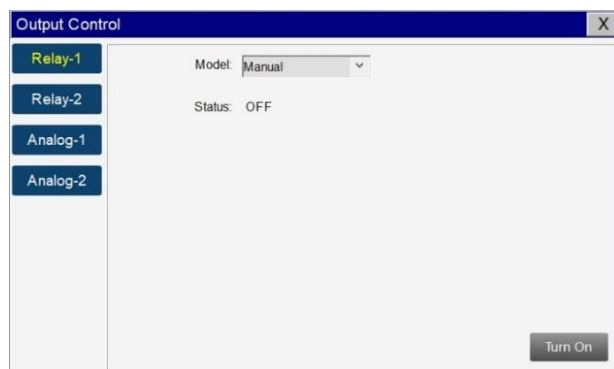

Figure. 14 – Manual

When the mode selection is **Periodicity**, it will periodically output according to the user programmed Interval Time and Running Time

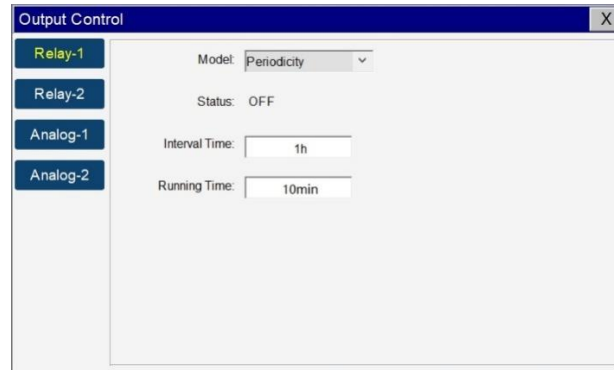

Figure. 15 – Periodicity (Timed Event)

When the mode selection is **Sensor Value**, users can select which parameters they desire to control. See examples below.

Example 1: Open (ON) Value = 0.2
 Close (OFF) Value = 0.5
 Measured Value \leq 0.2 will Open the Relay
 Measured Value \geq 0.5 will Close the Relay

Example 2: Open (ON) Value = 0.5
 Close (OFF) Value = 0.2
 Measured Value \leq 0.2 will Close the Relay
 Measured Value \geq 0.5 will Open the Relay

Users can utilize the **Protection Time** to prevent over activation of the relay if the responding parameter does not come within desired range within a specified time. After relay opening, when the measured value continues to exceed the set shutdown value beyond the protection time, the relay will automatically shut down the output. This feature allows for overfeed prevention.

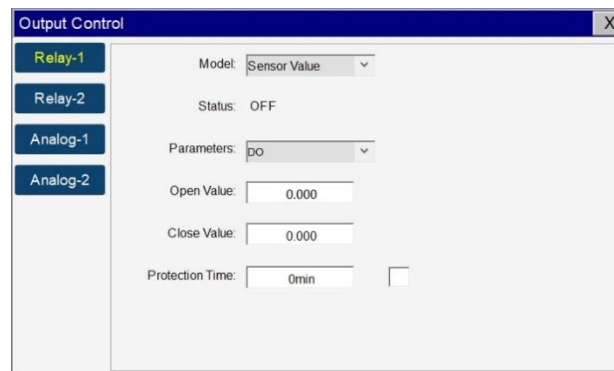

Figure. 16 – Sensor Value

The setting interface of Analog Output is the same as that of Relay Control. You can set Analog Control by referring to the setting description of Relay Output

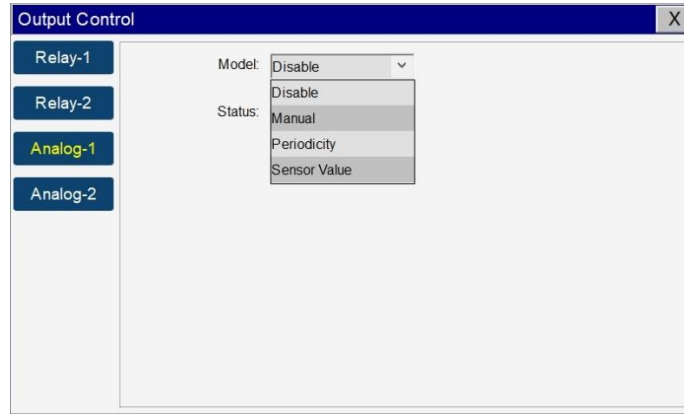

Figure. 17 – Analog Output Control

9.6.3. User Defined Settings

The “User Defined” setting function allows users to assign a customized name, unit of measure and analyzer type used to any of the sensor channel inputs displayed on the IK-2000 series.

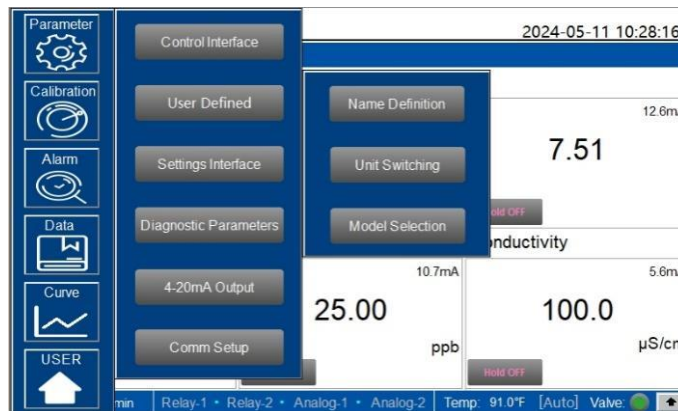

Figure. 18 – User Defined Settings

Parameter Name Definition

Click the orange dialog box to customize the sensor name.

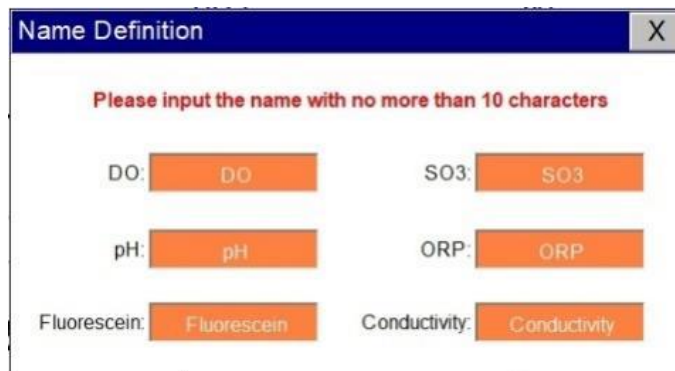

Figure. 19 - Name Definition

Unit of Measure Switching

Users can change the unit of temperature and flow rate in "Unit Switching".

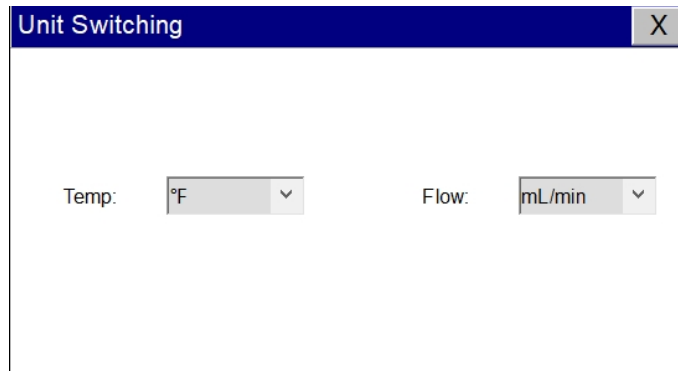

Figure. 20 - Unit Switching

Device Selection

The IK-2000 series are shipped with the correct device selected, if an additional sensor is purchased and later added due to application change, the user will need to select the corresponding device to enable display, calibration interface, diagnostics and sensor data storage/communication. Please refer to Specifications Section 1.0 for an overview of the sensors connected with each category of Guardian IK-2000 Series boiler feedwater analyzer.

****NOTE*** For any sensors not connected physically to the Guardian, the HMI will display ***** where there is no sensor data communication. (i.e. IK-2030 with only 3 of the 4 optional sensors connected)*

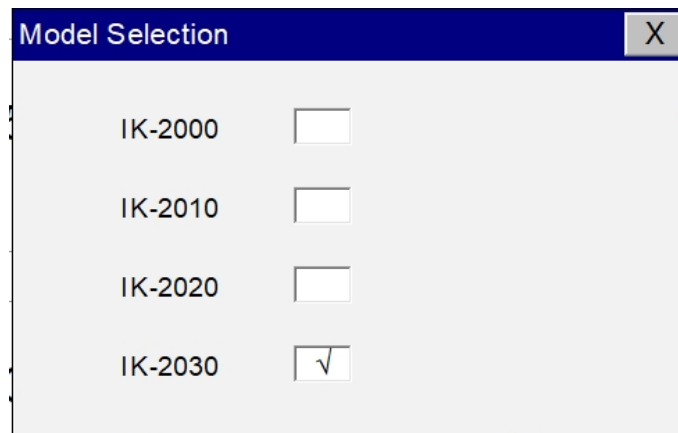

Figure. 21 - Device Selection

9.6.4. Settings Interface

Clicking on "Settings Interface" tab opens a sub-menu for Alarm Parameters and Sensor Parameters.

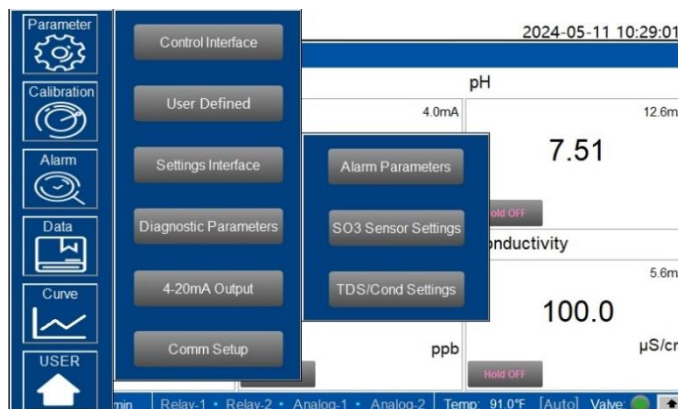

Figure. 22 – Setting Interface

Alarm Parameters Setting

Users can set the upper and lower alarm limits. Click "Alarm Parameters" to enter the alarm parameter settings. When the measured sensor value is lower than the set lower limit (the XX lower limit alarm) or when the measured value is higher than the set upper limit (the XX upper limit alarm), the corresponding sensor alarm will be displayed on the real-time monitoring screen. The user can also choose to turn the alarm display on or off at the top right of the corresponding parameter list.

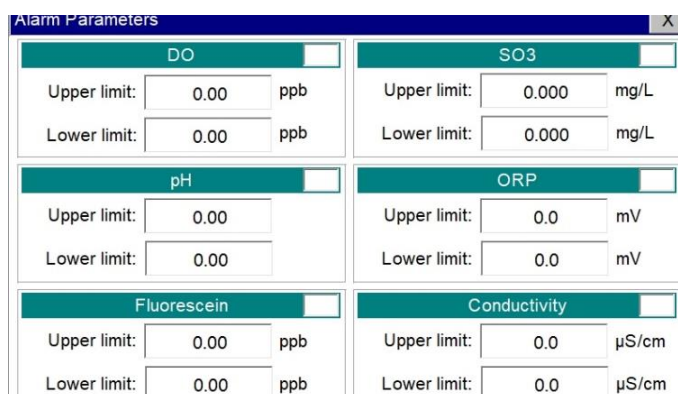

Figure. 23 - Alarm Parameter Setting

Sensor Parameters - Smoothing Factor Description & Adjustment for SO3 (Sulfite)

In "Sensor Parameters" within the "Settings Interface" field of the "Parameter" menu, users can set the smoothing coefficient for the sensor. Usually the sulfite concentration is a very small signal, which is easily subject to external interference. The ST-765SS-SO3 sensor adopts a continuous smoothing and averaging algorithm to filter out these minor interferences. A suitable smoothing factor setting can allow users to obtain a high-quality measurement and suitable dynamic response based on the application needs. The smoothing factor setting regulates the speed of sensors response.

The higher the smoothing factor value, the faster the sensor response and the lower the interference and noise suppression enabling a more rapid response to any changes of the real value. The lower the smoothing factor value, the slower the sensor response and the better the interference and noise suppression, but the slower the response to the real value change.

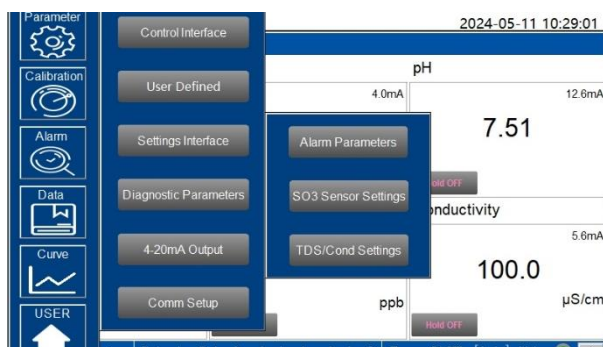

Figure. 24 - Settings & Sensor Parameters Interface

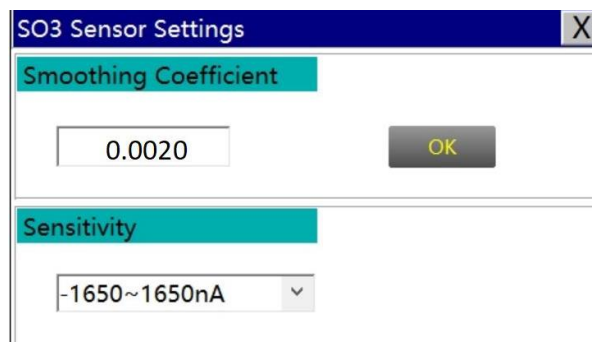

Figure. 25 - Smoothing Coefficient

See the next page for Smoothing Factor settings chart.

Pyxis Lab uses the term “T90” when the measured value of the sensor reaches 90% of the true value to describe the speed of the sensor response in seconds. The default smoothing factor of ST-765SS-SO3 sensor is **0.002 (T90≈4 minutes)**. The available setting range of the smoothing factor is 0.001 to 0.9. The following table outlines the comparison between the smoothing factor and T90 for the ST-765SS-SO3 sensor and should be used if considering an adjustment to the smoothing factor settings.

Smoothing Factor	T90 (Seconds)
0.1	5.5
0.09	6
0.08	7
0.07	8
0.06	9.25
0.05	11.25
0.04	14
0.03	19
0.02	28.5
0.01	57.25
0.009	63.75
0.008	71.75
0.007	82
0.006	97.5
0.005	114.75
0.004	143.5
0.003	191.5
0.002	287.5

$$T_{90} \approx 0.538 * Smooth_factor^{-1.013}$$

NOTE The smoothing coefficient is not available when the sensor is in calibration mode.

TDS (Total Dissolved Solids – ppm) to Conductivity Ratio Setup

Click "TDS/Cond Settings" to enter the setup interface, where Total Dissolved Solids (TDS) or conductivity can be selected according to the sensor, and the conversion factor can be set by the user below.

NOTE The UC-100AGS will be preprogrammed with a default ratio of 0.67x Conductivity = TDS (ppm).

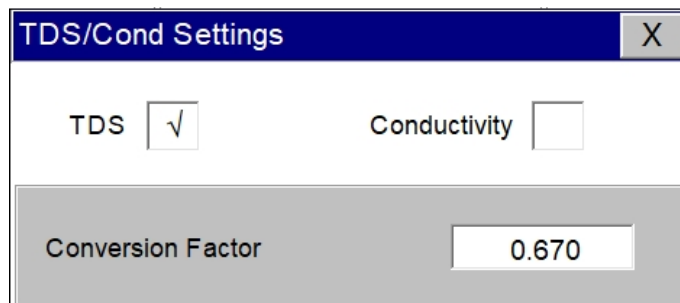

Figure. 26 - TDS/Cond Settings

9.6.5. Diagnostic Parameters for Troubleshooting Support

Click “**Diagnosis Parameters**” to enter the diagnosis page. In the diagnosis page, the raw data measured by the probe is displayed. To help troubleshooting possible issues with the probe, please take an image of this data when the probe is placed in a clean water (tap water or deionized water), in a standard, and in the sample that the probe is intended for. These images may be sent to service@pyxis-lab.com for troubleshooting support.

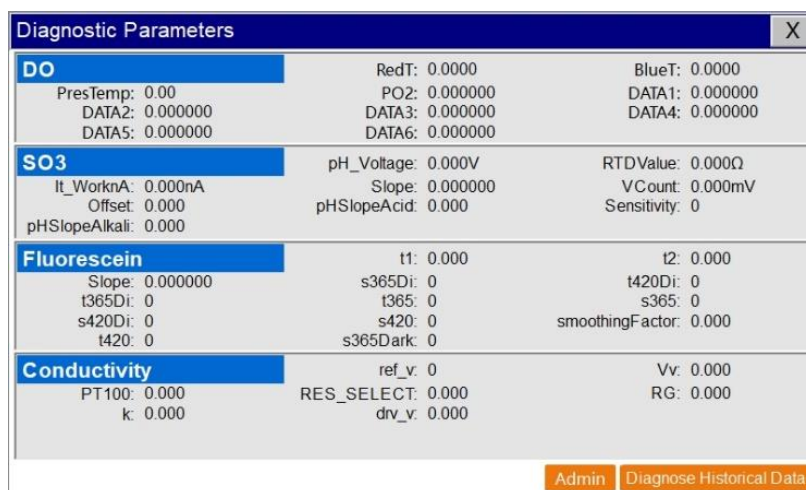

Figure. 27 - Diagnostic Parameters

Click on **“Diagnostic History Data”** in the lower right corner to access to view previous diagnostic parameters. Data can also be exported and made available for support from the Pyxis Lab Service Department.

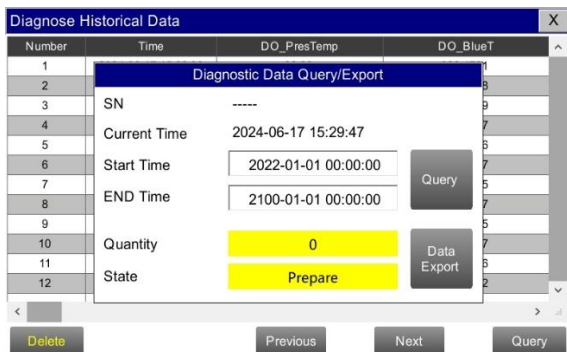

Figure. 28 - Diagnostic History Data

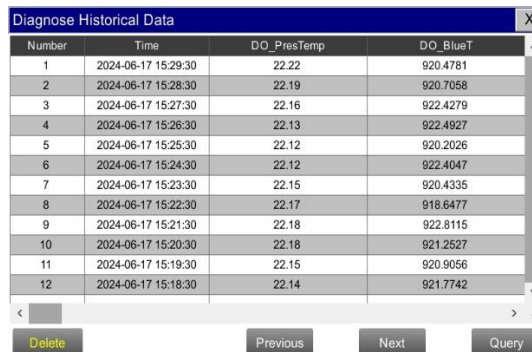

Figure. 29 - Diagnostic History Data Query

9.6.6. 4-20mA Output Signal Range Parameter Settings & Adjustment

Click **"4-20mA Output"** to enter the 4-20mA output parameter setting interface. The 4mA and 20mA output values should correspond to the default lower and upper limits of the sensor range. These values may be adjusted by the user as desired. ****NOTE*** The closer the value is set to the measurement value the more accurate the data. It is recommended to set according to the range of the sensor.*



Figure. 30 - 4-20mA Output Setting

9.6.7. UC-100AGS Modbus Communication Settings

If the site desires to connect the UC-100AGS outputs to a DCS (Distributed Control System) for the purposes of information and process control, users can connect the master station device to the UC-100AGS through the HMI (Human Machine Interface) terminal and read the data according to the parameter register table provided in Section 10.1 of this manual)

Modbus RTU (RS-485) and Modbus TCP and Ethernet Address settings are preset but may be altered by the user as desired.

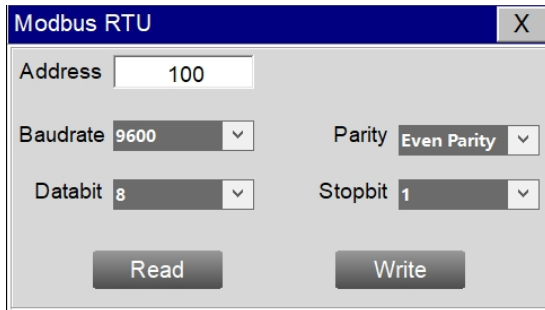

Figure. 31 - Modbus RTU

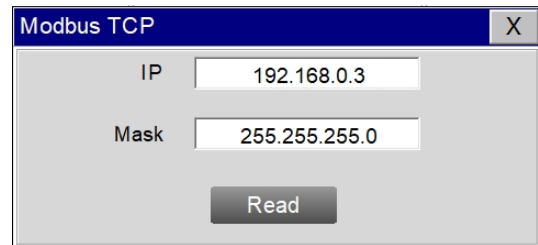

Figure. 32 - Modbus TCP

9.7. Sensor Calibration

Click on the "Calibration" button in the menu bar and select the sensor function desired for calibration.

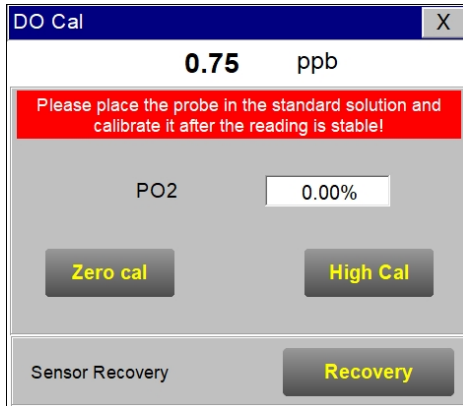

Figure. 33 - Sensor Calibration

9.7.1. Dissolved Oxygen (DO) Calibration – ST-774

From the calibration screen you can perform calibrations by pressing on Zero Calibration, High Point Calibration

****IMPORTANT NOTE**** Before calibrating, remove the ST-774 sensor from the water and wipe it with a damp cloth to remove debris and any fouling (i.e. iron oxide). If there is water on the membrane, dry it with a soft cloth taking care not to damage the membrane.



NOTE Click the Recovery button in the calibration interface of the sensor to restore the factory calibration settings if a user error is made during calibration and other operations. This will restore the factory settings of the sensor through this function.

Figure. 34 - DO Calibration

Zero Calibration Using Sulfite ZERO Calibration Kit (P/N 16019)

- 1) Unscrew the lid from the 10mL vial containing catalyzed sodium sulfite powder (P/N - SO3 VIAL).
- 2) Fill the vial with DI water to the 10mL mark.
- 3) Screw the lid on the vial and gently shake for 10 seconds.
- 4) Remove the Sulfite Zero Calibration Cap from packaging.
- 5) Unscrew the lid from the 10mL vial and pour the solution into the calibration cap



- 6) Rotate the calibration cap slowly over the front of the sensor. ***NOTE***: Any excess calibration fluid will flow out from the overflow port.

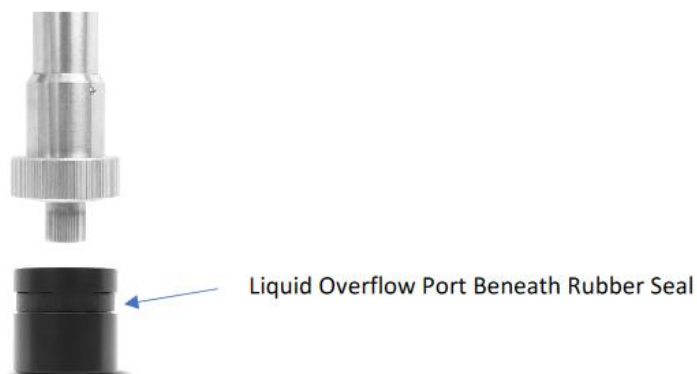

- Place sensor in upright position on the Guardian calibration shelf with the filled calibration cap at the bottom.



Position sensor vertically on Guardian shelf during ZERO calibration process

- Click the Zero Calibration button on the screen and let the sensor remain on the calibration shelf in the standing position with sulfite solution for 12 hours for best results. This allows the catalyzed sulfite to completely react with any remaining dissolved oxygen in the cap until true zero.

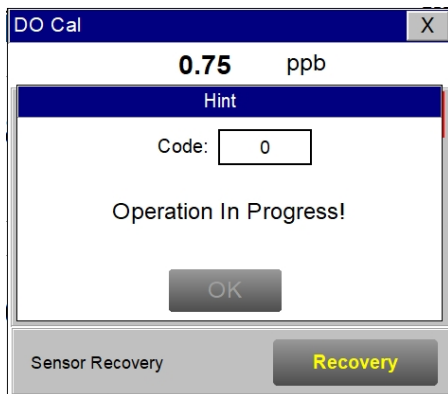

Figure. 35 DO Calibration Prompt

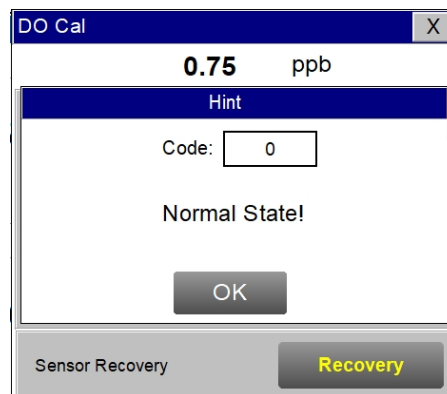

Figure. 36 Calibration Completed

- After the 12-hour period, remove the calibration cap from the ST-774 sensor and rinse the sensor tip with DI water and insert sensor back into the ST-774 Flow Cell Assembly for service.



ST-774 Flow Cell Assembly

Alternative Zero Calibration Using Pure Nitrogen Calibration Gas (99.999% or better)

A depressurized nitrogen gas source can be connected to the sample cell through the ¼-inch OD stainless tubing for the zero-point calibration. The gas flow rate should be regulated between 2 and 10 liter per minute. ***IMPORTANT NOTE*** Always ensure the stainless-steel compression fittings are very tight and always use stainless steel OD tubing.

- 1) Connect pure Nitrogen gas cylinder output line to Guardian sample inlet.
- 2) Place the sensor into the ST-774 Flow Cell Assembly.
- 2) Turn on a nitrogen gas flow.
- 3) Allow the gas flow through the Guardian tuing to atmpshere until the temperature reading on the UC-100AGS has been stabilized for at least 15 minutes.
- 4) Once the displayed oxygen and temperature values are stable, press Zero Calibration to perform a zero calibration.
- 5) If the calibration is successful, the interface will return a message "Calibration Succeeded". If the calibration fails, press Zero Calibration again and repeat.

High Point/Slope Calibration Using Nitrogen Gas 99.9% with 0.1% Oxygen Calibration Gas

A depressurized nitrogen with oxygen gas source can be connected to the sample cell through the ¼-inch OD stainless tubing for the high-/slope calibration. The gas flow rate should be regulated between 2 and 10 liter per minute. ***IMPORTANT NOTE*** Always ensure the stainless-steel compression fittings are very tight and always use stainless steel OD tubing.

- 1) Carry out the zero-calibration using nitrogen gas first. See the Zero Calibration section.
- 2) Connect the Nitrogen (99.9%) with Oxygen (0.1%) gas cylinder output line to Guardian sample inlet.
- 2) Place the sensor into the ST-774 Flow Cell Assembly.
- 3) Turn on a calibration gas (with known oxygen concentration) flow.
- 4) Allow the gas flow and the temperature to be stabilized for 15 minutes.
- 5) Once the displayed oxygen and temperature values are stable, press High Point Calibration
- 6) Enter the % Oxygen concentration of the calibration gas to perform a high point (slope) calibration.
- 7) If the calibration is successful, the interface will return a message "Calibration Succeeded". If the calibration fails, press High Point Calibration again and repeat

ST-774 Service SWAP Program (P/N ST-774-SWAP)

The ST-774 Service SWAP program is an alterative for users that do not want to conduct annual field calibration and maintenance of their ST-774. See overview of this service program below.

- (a) \$700 Per Year Factory Certified & Calibrated Sensor Only Exchange
- (b) Client Issues PO# to Pyxis Lab
- (c) Pyxis sends a factory certified new or reconditioned ST-774 sensor unit (without flow cell)
- (d) Client sends Pyxis their older ST-774 sensor unit (without flow cell)
- (e) Even exchange – eliminates client calibration and maintenance
- (f) Suggested annually
- (g) Contact order@pyxis-lab.com for details.

9.7.2. Sulfite (SO3) Calibration – ST-765SS-SO3

Zero Calibration

NOTE Under normal circumstances, the ZERO calibration of the ST-765 series sensor is not recommended or required, Pyxis Lab suggests Process Slope calibration only, unless otherwise directed via Pyxis Lab technical support team. Please refer to the Process Slope calibration procedure section for details.

If a zero calibration must be conducted, the Sulfite Zero calibration should be selected on the Sensor Calibration page. First put the sensor into the Zero-Oxidizer Standard Solution (Pyxis P/N 21022) or 100us/cm Conductivity Standard is also acceptable for zero standard solution. After the sensor reading is stable for at least 10 minutes, click the “Zero cal” button to start the zero calibration. If the calibration is successful, the dialog box will display "Calibration Successful".

Process Slope Calibration

While the sensor is exposed to an active sample flow of 100-500mL/min through the ST-765SS-SO3 sensor tee assembly, enter the measured Sulfite residual determined by the titration method or the Pyxis Sulfite Dropper Test Kit (P/N: TK35290-Z) and ensure that sensor reading has been stable for at least 10 minutes before calibration, click the “Process Calibration” button to start the process calibration. If the calibration is successful, the dialog box will display "Calibration Successful".

NOTE Click the Recovery button in the calibration interface of the sensor to restore the factory calibration settings if a user error is made during calibration and other operations. This will restore the factory settings of the sensor through this function.

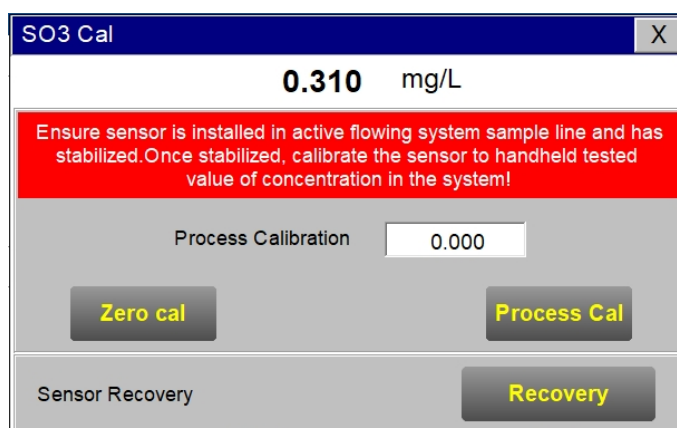

Figure. 37 – Sulfite Calibration of ST-765SS-SO3

9.7.3. pH Calibration – ST-765SS-SO3

The pH function is thoroughly calibrated at the Pyxis Lab factory prior to shipment. After removing the sensor and cleaning if necessary using Pyxis Probe Cleaner (P/N: SER-01) as outlined in Section 11.3 of this manual, check the sensor it with a pH standard buffer solution in a beaker. If the sensor value has shifted, then the user may choose from single-point, two-point or three-point calibration to re-calibrate the pH portion of the ST-765SS-SO3 sensor as desired. Pyxis Combo pH 4-7-10 Calibration Standard Kit (P/N:57007) or similar is suggested.

NOTE Click the Recovery button in the calibration interface of the sensor to restore the factory calibration settings if a user error is made during calibration and other operations. This will restore the factory settings of the sensor through this function.

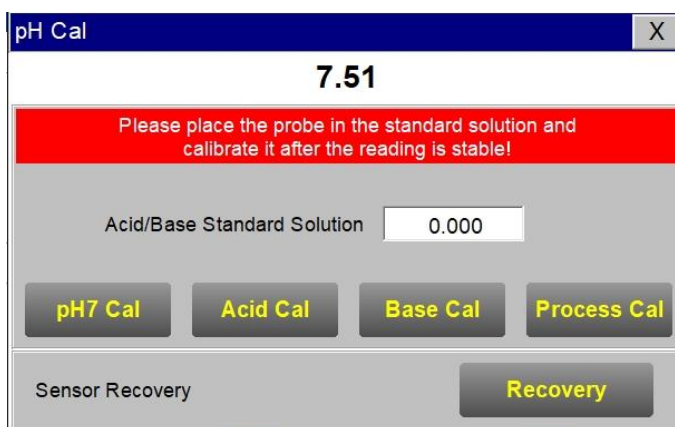

Figure. 38 - pH Calibration

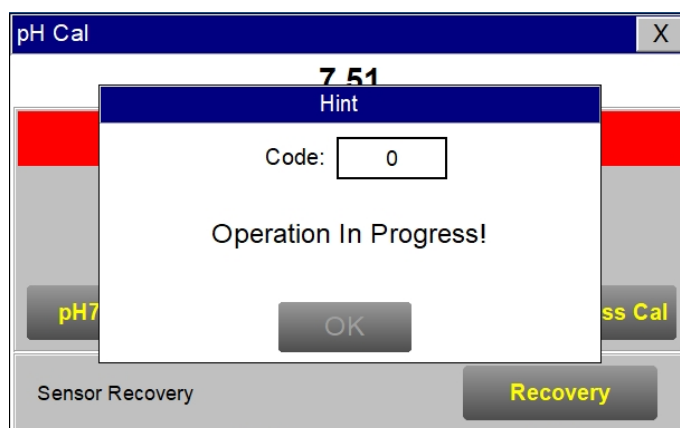

Figure. 39 - pH Calibration Prompt

A **Process Calibration** can be used if the pH calibration standard is not readily available for high, mid, and low calibration, or if there is a fixed deviation between the actual water sample and the true value after the user has done the calibration test. The pH process calibration is actually a correction (-0.5 to 0.5 pH units) made to the true pH value as measured by the sensor. Anything outside this range will require a formal calibration using pH calibration standard solution.

Single Point pH Calibration:

Remove the ST-765SS-SO3 sensor and rinse 3x with DI water ensuring there is no debris or fouling of the sensor electrode head. Submerge the sensor into a beaker with pH=7 buffer solution. Click "**pH7 calibration**". A dialog box will pop up to confirm whether to perform this operation, click "**OK**" if the calibration operation is confirmed, if the calibration is successful the dialog box will show "**Calibration Success**".

Two Point pH Calibration

Remove the ST-765SS-SO3 sensor and rinse 3x with DI water ensuring there is no debris or fouling of the sensor electrode head. Submerge the sensor into a beaker with pH=7 buffer solution. Click "**pH7 calibration**". A dialog box will pop up to confirm whether to perform this operation, click "**OK**" if the calibration operation is confirmed, if the calibration is successful the dialog box will show "**Calibration Success**".

After pH7 is successfully calibrated, you can choose Acid Calibration or Alkali Calibration for the second calibration point. If you choose Acid Calibration, clean beaker 3x with deionized water. Fill the beaker with pH=4 buffer solution. Enter the value 4 in the calibration value dialog box, and click "**Acid Calibration**", then a dialog box will pop up to confirm whether to perform this operation. Click "**OK**" if the calibration operation is confirmed and the dialog box will show "**Calibration Successful**" if the calibration is successful. Similarly a pH=10 buffer solution can be selected for the second point calibration if desired. Figure.



Figure. 40 - pH Calibration Value Input

Three Point pH Calibration:

Remove the ST-765SS-SO3 sensor and rinse 3x with DI water ensuring there is no debris or fouling of the sensor electrode head. Submerge the sensor into a beaker with pH=7 buffer solution. Click "**pH7 calibration**". A dialog box will pop up to confirm whether to perform this operation, click "**OK**" if the calibration operation is confirmed, if the calibration is successful the dialog box will show "**Calibration Success**".

After pH7 is successfully calibrated, you can choose Acid Calibration or Alkali Calibration for the second calibration point. If you choose Acid Calibration, rinse the beaker 3x with deionized water. Fill the beaker with pH=4 buffer solution. Enter the value 4 in the calibration value dialog box, and click "**Acid Calibration**", then a dialog box will pop up to confirm whether to perform this operation. Click "**OK**" if the calibration operation is confirmed and the dialog box will show "**Calibration Successful**" if the calibration is successful.

After successful Acid Calibration, select pH=10 for Alkali Calibration. Rinse the beaker 3x with deionized water. Fill the beaker with pH=10 buffer solution. Enter the value 10 in the calibration value dialog box, and click "**Alkali Calibration**", then a dialog box will pop up to confirm whether to perform this operation. Click "**OK**" if the calibration operation is confirmed and the dialog box will show "**Calibration Successful**" if the calibration is successful. The three-point calibration is completed.

9.7.1. ORP Calibration – ST-765SS-SO3

Close the water inlet valve and remove the sensor and rinse 3x with DI water ensuring there is no debris or fouling of the sensor electrode head. If the sensor is fouled, clean it using the Pyxis Probe Cleaning Kit (P/N: SER-01) as outlined in Section 11.3 of this user manual. Once clean submerge the sensor into a beaker filled with Pyxis ORP-200 Calibration Standard Solution (P/N: 57020) or similar. Enter the known concentration of the ORP standard solution in the calibration screen and click “Calibrate”. A dialog box will pop up to confirm whether to perform this operation. If the calibration operation is confirmed, click “OK”. If the calibration is successful, the dialog box will display "Calibration Successful".

NOTE Click the Recovery button in the calibration interface of the sensor to restore the factory calibration settings if a user error is made during calibration and other operations. This will restore the factory settings of the sensor through this function.

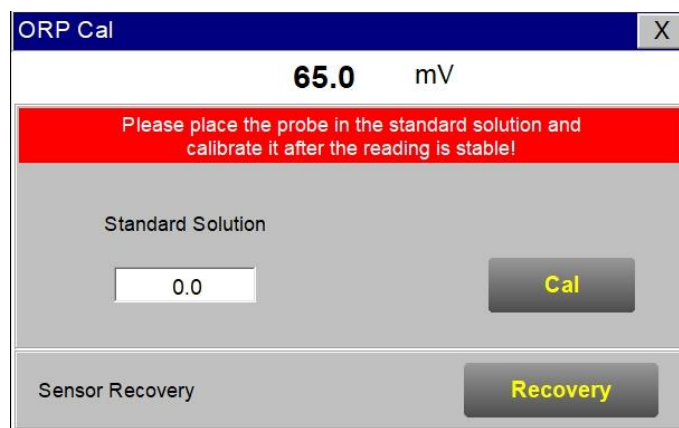

Figure. 41 - ORP Calibration

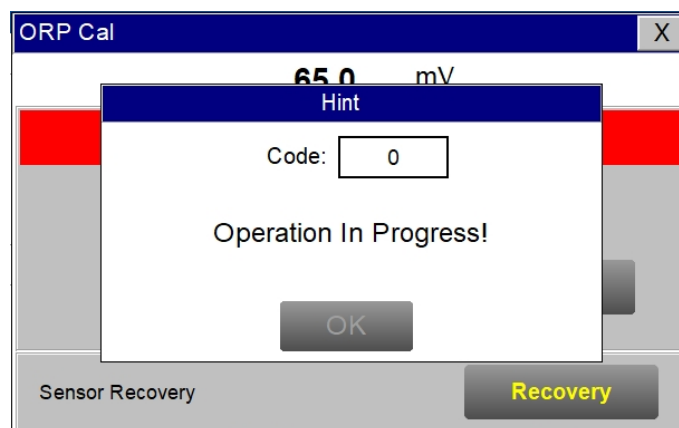

Figure. 42 - Awaiting Execution Screen

9.7.2. Fluorescein (Tracer) Calibration – ST-525SS-T

Single Point (In-Situ) Fluorescein Calibration

Remove and clean the ST-525SS-T series sensor using Pyxis Probe Cleaner (P/N: SER-01) as outlined in Section 11.3 of this manual. is clean by using the Cleanliness Check Function of the Diagnostic tab, users may conduct an in-situ slope calibration of Fluorescein while the sensor is in operation. Place the sensor into Fluorescein calibration standard solution (based on the sensor in use) , enter the standard solution value in the interface, then click “**High calibration**”, wait for the calibration completion prompt to pop up, which means the calibration is successful. ***IMPORTANT NOTE* If the sensor is dirty, it must be removed for proper optical channel cleaning with the Pyxis Probe Cleaning Solution (P/N SER-01) prior to conducting sensor calibration.**

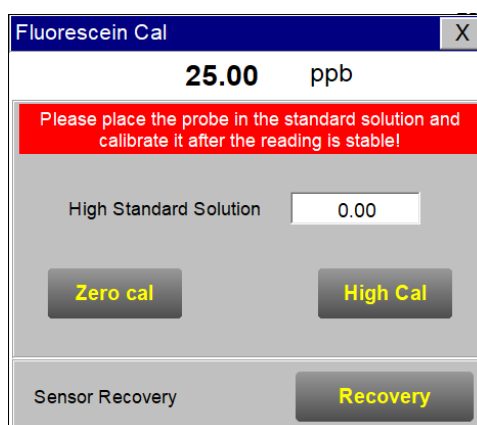

Figure. 43 Fluorescein Calibration

***IMPORTANT NOTE*:** For best results, the ST-525SS-T sensor should be calibrated in a completely light-proof environment by covering the beaker with a towel.

Two-Point (Beaker) Fluorescein Calibration

Two-point Fluorescein calibration for the ST-525SS-T series requires the following Pyxis calibration standards for adequate Zero and Slope calibration.

Calibration Point	Item Name	Pyxis P/N
Zero Calibration	DI Water	NA
Slope Option #1	10ppb Fluorescein Std. Solution	FLUO-10
Slope Option #2	20ppb Fluorescein Std. Solution	FLUO-20

After cleaning the sensor, place the sensor into a beaker containing deionized (DI) water. Please allow sufficient time (a few minutes) for the sensor to stabilize before performing the calibration, then tap **Zero Calibration**.

After completing the zero calibration, place the sensor into FLUO-10 or FLUO-20 calibration standard solution (based on application need) , enter the standard solution value in the interface, then click “**High Calibration**”, wait for the calibration completion prompt to pop up, which means the calibration is successful.

9.7.3. Conductivity (TDS) Calibration – ST-724

The conductivity sensor only needs to be calibrated once, put the sensor into the standard solution with known standard solution value, enter the standard solution value in the interface, then click “Calibration”, wait for the calibration completion prompt to pop up, which means the calibration is successful.

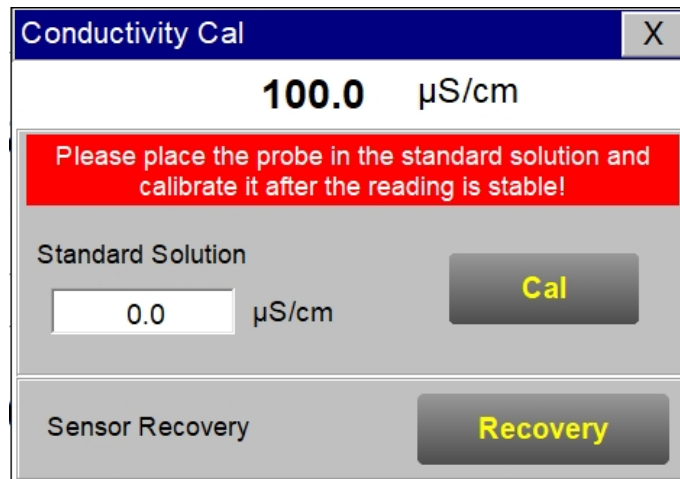

Figure. 44 Conductivity Calibration

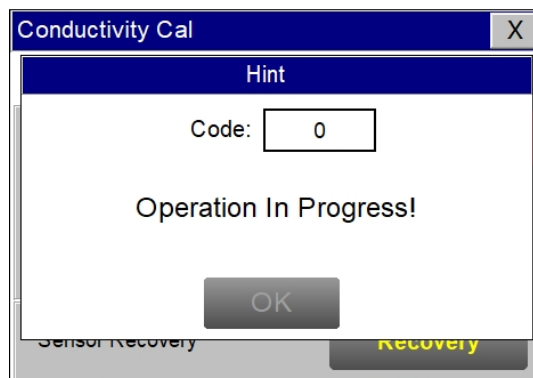

Figure. 45 Conductivity Calibration-2

9.8. Alarm View

Click the "Alarm View" button on the main screen to enter the alarm view screen.



Figure. 46 - Alarm View

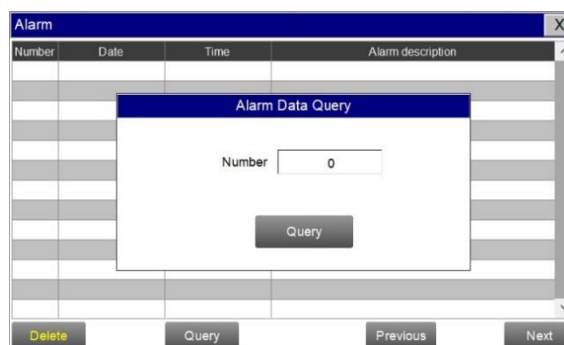

Figure. 47 - Alarm Data Query Screen

In this screen users can browse all logged alarms. Drag the right scroll bar up and down to view the history of alarms. Click "Previous" and "Next" to advance to the next page. Click "Query" then enter the alarm number in the pop-up box to query that alarm. The Delete button in the lower left corner will delete all alarm records. After clicking delete, you must exit the screen and reenter before the historical data within the data report will be cleared.

9.9. Historical Data – Query, View & USB Download

Click on "Data" to view historical data and calibration logs. Click the "Historical Data" button in the menu bar to enter the data report interface.

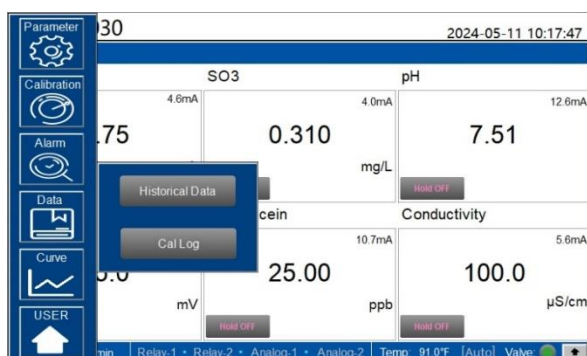

Figure. 48 – Data

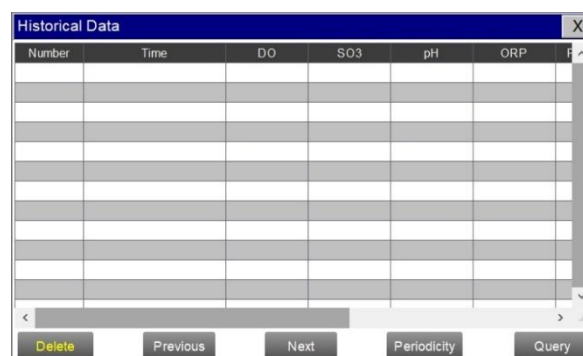

Figure. 49 - Historical Data Screen

In the data report, the user can view the stored data of all parameters. The system records sensor readings every 4 seconds by default but this can be edited by the user if desired. Drag the scroll bar on the right to slide up or down or click "Previous" and "Next" to view historical data records. The data record can save up to 100,000 data entries. New data will overwrite the previously saved data after recording 100,000 data entries. The user can click the "Periodicity" button to change the data recording time interval. Click "Delete" in the lower left corner. After entering the retention time, click the "Delete" button to clear all historical data within the retention time range.

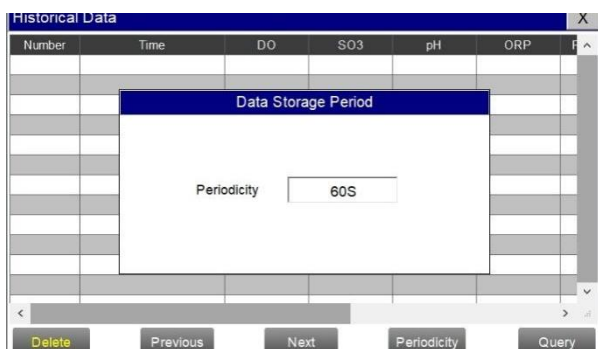

Figure. 50 - Data Storage Cycle Time Setting Figure.

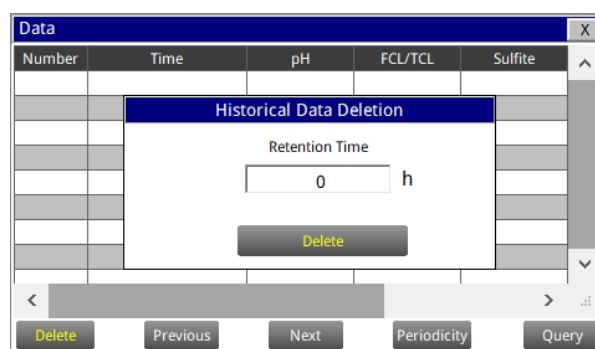

Figure. 51 - History Data Deletion Screen

Click the **“Query”** button in the lower right corner, enter the start time and end time and then click the **“Query”** button. ***NOTE*** The start time and end time must be filled in exactly and completely according to the system time format of Year / Month / Day / Hours / Minutes / Seconds.

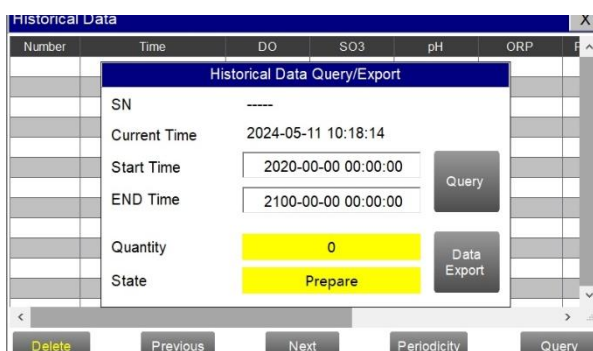

Figure. 52 - Historical Data Query and Export

Insert a USB disk behind the HMI display screen and enter the time range of the data to be exported in the query area. Click on the **“Data Export”** to download the data to the USB disk. The data quantity will be shown as a positive number if data export is successful. If the data export was not successful, please check whether the time format is correct. ***IMPORTANT NOTE*** Please be sure to use an empty (no saved files) FAT32 formatted USB disk with data capacity of 32-64GB.

When a **Quantity** value appears, refer to the following table to troubleshoot the issue. Contact service@pyxis-lab.com for support on these alarms if they arise.

Quantity	Description
-1001	Progress or control data object type is incorrect
-1004	Group object name does not exist or the group object does not have the save property
-1020	The start time of the export is greater than the end time
-1021	USB flash drive is not inserted
-1022	Only one export task is allowed at the same time
-1023	The number of records read is 0
-1024	File operation failed
-1025	Export path is empty
-1026	Export path is not legal
-1027	Incorrect time format
-1028	Unsupported export mode

Calibration Log

The calibration log can be viewed in the calibration log interface, and when the export operation is performed, the diagnostic parameters, historical data, and calibration log will be exported simultaneously.

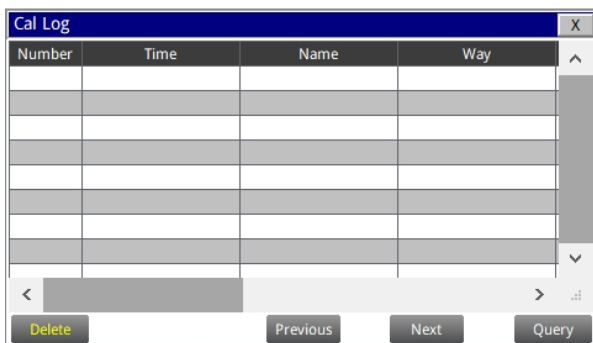

Figure. 53 - Calibration Log



Figure. 54 - Calibration Log Query/Export

9.10. Historical Data Curves

Click the "Historical Curve" button in the menu bar to enter the trend curve interface. You can click the buttons below the X-axis to browse and view the values in a different time range. Click on Y-axis Range to change the minimum and maximum Y-axis values for a proper range.

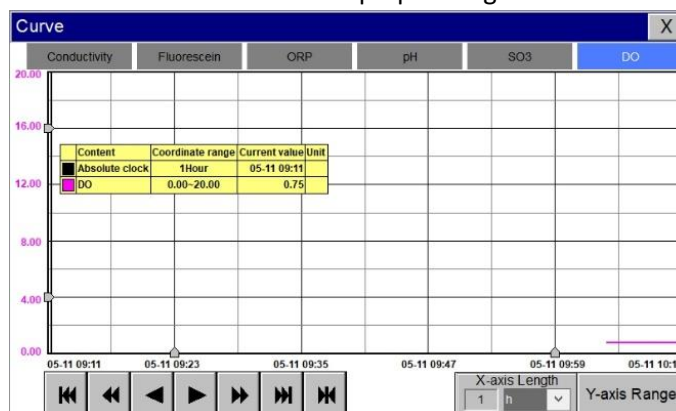

Figure. 55 - History Curve Screen

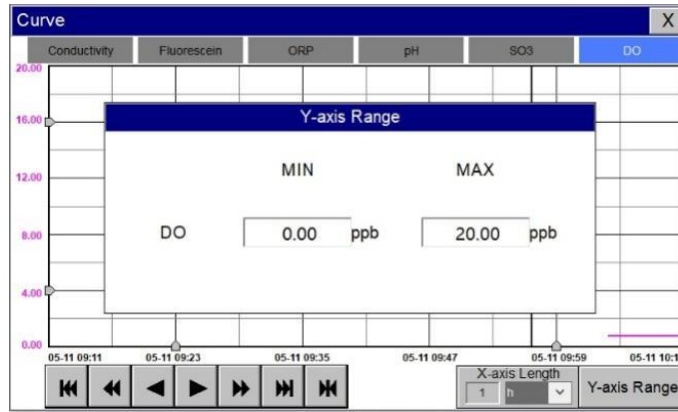

Figure. 56 - Y-axis Range Setting 1-2

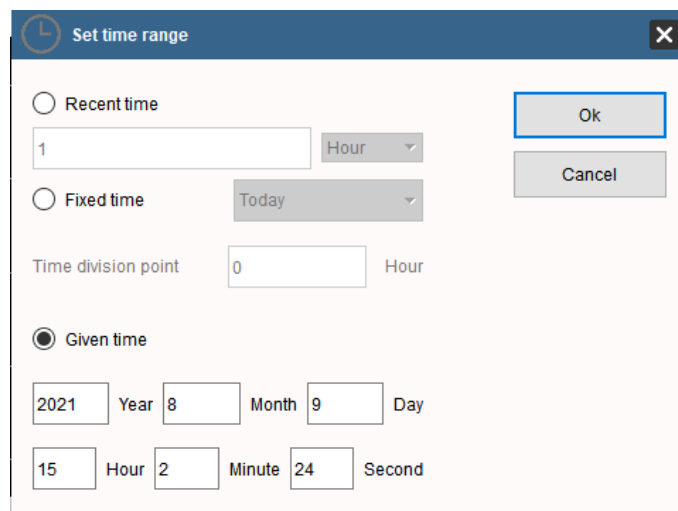

Figure. 57 - Time Setting Screen

Please refer to the button description overview for Historical Curve Function navigation.

- The curve will scroll back (to the left of the X-axis) one page
- The curve will scroll back (to the left of the X-axis) half the page of the curve
- The curve will scroll backward (to the left of the X-axis) to a position where the main line is drawn
- The curve will scroll forward (to the right of the X-axis) to a position where the main line is drawn
- The curve will scroll forward (to the right of the X-axis) half the page of the curve
- The curve will scroll forward (to the right of the X-axis) one page
- A dialog box will pop up to reset the starting time of the curve

Figure. 58 - Button Function Review

9.11. User Management

Click the "User" button on the menu bar and then you can select "Login", "Logout" and "Manage" operations.



Figure. 59 - User Management

Logout enables the user to log out of the logged-in state and only view the real-time readings, but cannot perform operations such as parameter settings. Click "Manage" to enter the user management interface, where you can add users, change passwords and other operations. Users can set their own user name and password and select the user group they belong to. Only users in the administrator group can set parameters such as calibration.

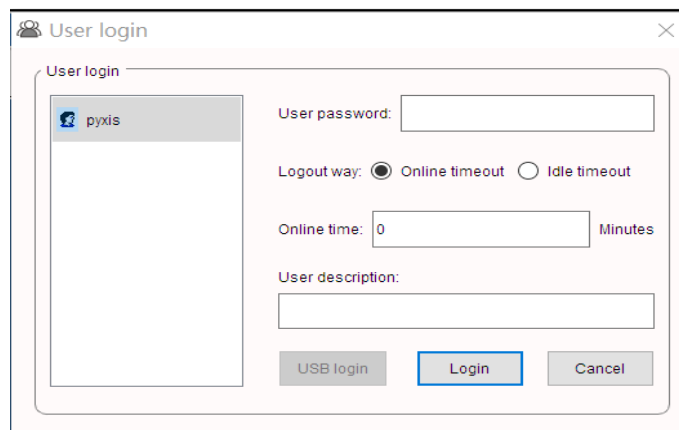

Figure. 60 - Modifying the User Screen

Modify Password: Select the user you want to change, then click "Modify User" button, enter the user's own password in the User Password column and Confirm Password column, and click "Confirm" to modify successfully.

NOTE If you do not want to set the password, you can delete the password and save it.

Modbus Register Table & Analyzer Maintenance

10.1. Modbus Correspondence Address

Serial Number	Definition	Address	Format	Mode	Unit	Note	
1	DO	1	float	read-only	mg/L	Data Format ABCD	
2	SO3	3	float	read-only	mg/L		
3	pH	5	float	read-only			
4	ORP	7	float	read-only	mV		
5	Fluorescein	9	float	read-only	ppb	0: Normal 1: Alarm	
6	TDS/Conductivity	11	float	read-only	ppm-μS/cm		
7	Temperature	13	float	read-only	°C/°F		
8	Sample Flow	15	float	read-only	mL/GPM		
9	Dissolved Oxygen upper limit alarm	17	uint	read-only			
10	Dissolved Oxygen lower limit alarm	18	uint	read-only			
11	SO3 upper limit alarm	19	uint	read-only			
12	SO3 lower limit alarm	20	uint	read-only			
13	pH upper limit alarm	21	uint	read-only			
14	pH lower limit alarm	22	uint	read-only			
15	ORP upper limit alarm	23	uint	read-only			
16	ORP lower limit alarm	24	uint	read-only			
17	Fluorescein upper limit alarm	25	uint	read-only			
18	Fluorescein lower limit alarm	26	uint	read-only			
19	Conductivity upper limit alarm	27	uint	read-only			
20	Conductivity lower limit alarm	28	uint	read-only			
21	The communication of the Dissolved Oxygen sensor is abnormal	29	uint	read-only			
22	The communication of the SO3 sensor is abnormal	30	uint	read-only			
23	The communication of the Fluorescein sensor is abnormal	31	uint	read-only			
24	The communication of the Conductivity sensor is abnormal	32	uint	read-only			
25	The PLC module communication is abnormal	33	uint	read-only			
26	Over Temperature Alarm	34	uint	read-only			
Communication Protocol: Standard Modbus-RTU							
Communication Parameters: Baud Rate - 9600 / Data Bit - 8 / Stop Bit -1 / Parity Bit - Even							
Station Number: 100							
Communication Protocol: Standard Modbus-TCP							
Communication Parameters: IP: 192.168.0.3 (can be set); port: 502							
Station Number: 1							

Table. 1 - Modbus Correspondence Address

10.2. Analyzer Operation and Maintenance

After the analyzer is installed by a qualified technician, it can begin to monitor water quality immediately. ****IMPORTANT NOTE**** Upon powerup of the analyzer, the ST-765SS-SO3 Series sensor will always conduct a 5-minute electrode initialization process to prepare the bare-gold for service. During this time, the sensor ***will not read an oxidizer value.*** After this cycle, the sensor will begin reading the live oxidizer value. The IK-2000 is designed to be simple to operate, but still requires some regular maintenance. Actual system maintenance may vary depending on the installation conditions and usage. Please refer to the table below as a general recommended maintenance schedule guideline. Little operator intervention is required during normal operation.

Required Services	Recommended Frequency	Procedure Location
Cleaning Inlet Water Filter Screen	Monthly or Cleaned As Needed	NA
Cleaning of Sensors & Electrode Heads	Monthly or Cleaned As Needed	Section 11.3
Dissolved Oxygen DCC-2 Cartridge Changeout	Annually	Section 11.2
Dissolved Oxygen Zero Sulfite Calibration	Annually or As Needed	Section 9.7.1
pH Calibration	Every 6 Months or As Needed	Section 7.7.1
ORP Calibration	Every 6 Months or As Needed	Section 7.7.2
Sulfite Calibration	Every 6 Months or As Needed	Section 7.7.3
EH-765 Electrode Head Replacement (SO3 Only)	Annually or As Needed	Section 11.1
Fluorescein Calibration	Monthly or As Needed	Section 9.7.2
Conductivity Calibration	Annually or As Needed	Section 9.7.3

Table. 2 - Maintenance Intervals

10.3. Instrument Alarms and Descriptions

Please refer to the instrument alarms and descriptions table when troubleshooting the IK-2000 inline inspection system issues an alarm or indicates abnormal measurement data.

Alarms	Description	Symptoms	Solutions/Recommendations
Sensor Communication Abnormalities	Sensor without Communication	No Measurements	Check the connection between the sensor and the circuit board. If the problem persists, contact Pyxis.
Dissolved Oxygen Upper Limit Alarm	Dissolved Oxygen above the Alarm Setting	Information Only	Compare with manual measurement readings. Check and clean line valves. Check that water flow is normal. Check that the sensor is clean.
Dissolved Oxygen Lower Limit Alarm	Dissolved Oxygen below the Alarm Setting	Information Only	
ORP Upper Limit Alarm	ORP above the Alarm Setting	Information Only	
ORP Lower Limit Alarm	ORP below the Alarm Setting	Information Only	
pH Upper Limit Alarm	pH above the Alarm Setting	Information Only	
pH Lower Limit Alarm	pH below the Alarm Setting	Information Only	
Sulfite Upper Limit Alarm	Oxidizer above the Alarm Setting	Information Only	
Lower Sulfite Limit Alarm	Oxidizer below the Alarm Setting	Information Only	

Table. 3 - Common Alarms

10.4. Replacing ST-765SS-SO3 pH, ORP and Sulfite Electrode Head

The EH-765 electrode head (P/N: 53061) of the ST-765SS-SO3 sensor can be replaced when the original electrode heads have reached the end of their working life. The typical working life of the electrode can be as long as 2-years under normal operating conditions. Please refer to the following steps to replace the electrode head of your sensor.

1. Isolate the sensor by turning off sample flow. Remove and make sure there is no water on the sensor.
2. Hold the sensor main body with one hand and use the other hand to twist the locking ring counterclockwise until the front end of the black electrode is completely unscrewed, as shown in Figure 61-2. ***NOTE*** *The sensor electrode head should be oriented towards the ground to avoid residual water getting into the sensor.*
3. Thoroughly wipe the electrode head with a dust-free cloth or paper-towel then pull out the electrode head as shown in Figure 61-3.
4. Gently loosen the electrode plug connector and remove the electrode head, as show in Figure 61-4.
5. To install the new electrode head, please use the mounting hook to securely plug in the wiring connector, as shown in Figure 61-5. ***NOTE*** *Before connecting the electrode head, please make sure that the new electrode head gasket is properly installed at the base of the electrode head thread to ensure a watertight seal, as shown in Figure 61-5.*
6. Then reconnect, insert the new electrode head into the main sensor housing and ensure that the two alignment protrusions on the electrode head are aligned with the notches in the sensor body housing, as shown in Figure 61-6. Then twist the lock ring of sensor in a clockwise direction until the threads of the electrode head completely enter the sensor housing as shown in Figure 61-1. ***NOTE*** *Be sure to return your sensor operation to Flow Interlock Auto Mode (Section 9.6.1)*



Figure. 61 - Replacing EH-765 pH, ORP and Sulfite Electrode Head

10.5. Replacing ST-774 Dissolved Oxygen Cartridge Assembly (DCC-2)

Remove the ST-774 dissolved oxygen sensor from the flow cell assembly. Slowly unscrew the DCC-2 (P/N: 53716) Membrane Cap from the ST-774 sensor. Gently clean the sensor eye and install the new replacement DCC-2 Membrane Cap onto the ST-774 sensor. Your sensor is now ready for service for another year of operation. ***NOTE*** Replacement of this cartridge is suggested annually.



10.6. Sensor Cleaning with Pyxis Probe Cleaning Kit

In the event of heavy inorganic deposition of any Pyxis sensors installed on the Guardian Boiler Feedwater Analyzer Series, users may conduct an off line chemical cleaning using the Pyxis Probe Cleaning Kit (P/N: SER-01). Remove the sensor and inspect the internal components of the stainless steel flow cell. If necessary flush the flow cell thoroughly with clean water until adequately clean. Fill the provided beaker and soak the lower half of the sensor in 100 mL of Pyxis Probe Cleaning Solution for 10-15 minutes. Gently wipe the sensor electrode head with the provided Q-tips. If an optical sensor (i.e. ST-525S-T), use the provided pipe cleaning brushes to gently brush the inner surfaces of the optical channel itself. If the surfaces are not entirely clean, continue to soak the sensor for an additional time until clean. Rinse the sensor with distilled water. Pyxis Lab Probe Cleaning Kit can be purchased at our online Estore/Catalog at <https://www.pyxis-lab.com/product/inline-sensor-cleaning-kit/>



Contact Pyxis Lab

21242 Spell Circle

Tomball, TX. 77375

service@pyxis-lab.com for technical service and support

order@pyxis-lab.com for order and pricing inquiries

1-866-203-8397 Phone USA for all needs

Office Hours 7AM – 5PM Central Time USA