

# Pyxis<sup>®</sup>

# OXIGO

## **SP-208 OXIGO Pocket Colorimeter**

*Free & Total Chlorine Handheld Colorimeter*



**Pyxis Lab<sup>®</sup> Inc.**  
21242 Spell Circle  
Tomball, TX 77375  
[www.pyxis-lab.com](http://www.pyxis-lab.com)

USER MANUAL



---

## Contents

|          |  |           |
|----------|--|-----------|
| <b>1</b> | <b>General Description</b> .....                 | <b>1</b>  |
| 1.1      | Major Features .....                             | 1         |
| <b>2</b> | <b>Specification</b> .....                       | <b>2</b>  |
| <b>3</b> | <b>Unpacking the Instrument</b> .....            | <b>3</b>  |
| 3.1      | Standard Accessories .....                       | 3         |
| 3.2      | Optional Accessories .....                       | 3         |
| 3.3      | Optional Reagents and HACH Cross Reference ..... | 4         |
| <b>4</b> | <b>Installation</b> .....                        | <b>5</b>  |
| 4.1      | Battery Installation .....                       | 5         |
| 4.2      | pH/ORP Module Installation .....                 | 6         |
| 4.3      | pH/ORP Module Installation Procedure .....       | 6         |
| 4.4      | pH/ORP Module Battery Installation .....         | 7         |
| <b>5</b> | <b>Instruction Overview</b> .....                | <b>8</b>  |
| 5.1      | pH/ORP Cell Cap Seal .....                       | 9         |
| 5.2      | Control Keys .....                               | 9         |
| 5.3      | Main Module On/Off .....                         | 9         |
| 5.4      | pH/ORP Module On/Off .....                       | 10        |
| <b>6</b> | <b>Measurement</b> .....                         | <b>10</b> |
| 6.1      | Switch Measurement Mode .....                    | 10        |
| 6.2      | DPD Free and Total Chlorine Measurement .....    | 11        |
| 6.2.1    | Supported Methods .....                          | 11        |
| 6.2.2    | Measurement Procedure .....                      | 11        |
| 6.3      | pH/ORP Measurement .....                         | 12        |
| 6.3.1    | Measurement Procedure .....                      | 12        |
| 6.3.2    | Erroneous Values .....                           | 12        |
| 6.3.3    | pH Measurement Principle .....                   | 13        |
| 6.3.4    | ORP Measurement Principle .....                  | 14        |
| <b>7</b> | <b>Calibration</b> .....                         | <b>15</b> |

|           |  |           |
|-----------|--|-----------|
| 7.1       | Free & Total Chlorine Calibration.....                             | 15        |
| 7.2       | pH Calibration.....  | 17        |
| 7.2.1     | One-Point Calibration .....  | 18        |
| 7.2.2     | Two-Point Calibration .....  | 18        |
| 7.2.3     | Three-Point Calibration .....                                      | 19        |
| 7.3       | ORP Calibration .....  | 20        |
| <b>8.</b> | <b>Device Information and Diagnosis .....</b>                      | <b>22</b> |
| 8.1       | Bluetooth Connection to uPyxis® Mobile or uPyxis® Desktop App..... | 23        |
| 8.2       | Factory Reset.....   | 23        |
| 8.3       | Bluetooth Paring to pH&ORP module .....                            | 24        |
| 9         | Use with uPyxis® 1.0 Mobile App .....                              | 25        |
| 9.1       | Download the uPyxis® 1.0 Mobile App .....                          | 25        |
| 9.2       | Connecting to the uPyxis® 1.0 Mobile App.....                      | 25        |
| 9.3       | Setting Screen.....  | 26        |
| 9.4       | System Screen .....  | 26        |
| 9.5       | Datalog Screen.....  | 27        |
| <b>10</b> | <b>Use with uPyxis® Desktop App.....</b>                           | <b>28</b> |
| 10.1      | Install uPyxis® Desktop App.....                                   | 28        |
| 10.2      | Connecting to uPyxis® Desktop App.....                             | 28        |
| 10.3      | System Screen .....  | 29        |
| 10.4      | Setting Screen.....  | 30        |
| 10.5      | Datalog Screen.....  | 31        |
| <b>11</b> | <b>Device Maintenance and Precaution .....</b>                     | <b>32</b> |
| 11.1      | Maintenance Best Practices and Quick Tips.....                     | 32        |
| 11.2      | Storage .....  | 32        |
| <b>12</b> | <b>Contact Us.....</b>   | <b>33</b> |

**Confidentiality**

The information contained in this manual may be confidential and proprietary and is the property of Pyxis Lab Inc. Information disclosed herein shall not be used to manufacture, construct, or otherwise reproduce the goods disclosed herein. The information disclosed herein shall not be disclosed to others or made public in any manner without the express written consent of Pyxis Lab Inc.

**Standard Limited Warranty**

Pyxis Lab warrants its products for defects in materials and workmanship. Pyxis Lab will, at its option, repair or replace instrument components that prove to be defective with new or remanufactured components (i.e., equivalent to new). The warranty set forth is exclusive and no other warranty, whether written or oral, is expressed or implied.

**Warranty Term**

The Pyxis warranty term is thirteen (13) months ex-works. In no event shall the standard limited warranty coverage extend beyond thirteen (13) months from original shipment date.

**Warranty Service**

Damaged or dysfunctional instruments may be returned to Pyxis for repair or replacement. In some instances, replacement instruments may be available for short duration loan or lease.

Pyxis warrants that any labor services provided shall conform to the reasonable standards of technical competency and performance effective at the time of delivery. All service interventions are to be reviewed and authorized as correct and complete at the completion of the service by a customer representative or designate. Pyxis warrants these services for 30 days after the authorization and will correct any qualifying deficiency in labor provided that the labor service deficiency is exactly related to the originating event. No other remedy, other than the provision of labor services, may be applicable.

Repair components (parts and materials), but not consumables, provided in the course of a repair, or purchased individually, are warranted for 90 days ex-works for materials and workmanship. In no event will the incorporation of a warranted repair component into an instrument extend the whole instrument's warranty beyond its original term.

**Shipping**

A Repair Material Authorization Number (RMA) must be obtained from the Technical Support ([service@pyxis-lab.com](mailto:service@pyxis-lab.com)) before any product can be returned to the factory. Pyxis will pay freight charges to ship replacement or repaired products to the customer. The customer shall pay freight charges for returning products to Pyxis. Any product returned to the factory without an RA number will be returned to the customer.



## 1 General Description

The SP-208 OXIGO™ is a unique pocket colorimeter specifically designed for measurement of free and total chlorine at low and high ranges (0.02–2.2ppm LR; 0.1–10.0ppm HR) in both Industrial & Municipal water treatment applications. The SP-208 offers colorimetric testing of this common oxidizing biocide/disinfectant using both Pyxis Lab® and conventional HACH® reagents. This handheld unit offers a simple user interface and an advanced live graphical display making Chlorine measurement effortless for water treatment professionals.



The SP-208 is factory calibrated & may be field calibrated utilizing our Pyxis DPD Chlorine Secondary Standard Solution (1 or 2ppm) For rapid accuracy verification, users may also desire to utilize the Pyxis DPD Chlorine Secondary Verification Kits (LR and HR). These kits consist of pre-made vials set to a specific Chlorine concentration. In the field, users can easily verify their handheld accuracy by inserting a pre-made vial and testing to match the vials concentration. Raw material qualities vary globally and as such field calibration may be required by the user to adjust for lower quality raw material used in point of application. This device is Bluetooth® 5.0 enabled for data log transfer, firmware updates and screen customization via the uPyxis® mobile and desktop app.

**\*NOTE\*** The SP-208 allows users to expand its functions by purchasing a Pyxis pH & ORP Module (P/N 50315), see section 5.0 for more details.

### 1.1 Major Features

The SP-208 is a handheld colorimetric analyzer that incorporates Pyxis' advanced technology in the field of optical measurement. Main features include:

- Utilizes both HACH® & Pyxis Lab® Powder Pillow Reagents
- Fully Integrated Test Times with Live Graphical Display of the Residual
- Meets EPA 334.0 - DPD Testing Guidelines for Drinking Water
- Bluetooth® Integrated for Wireless Data Transfer & Customization
- Data Logging - 30,000 Group Storage
- Users may set Date, Time, Language, Screen Auto Off Time, Meter Auto Off Time directly on the OXIGO Long standby mainframe 10,000+ measurements.
- Expand pH and ORP capabilities with the optional pH&ORP module

## 2 Specification

**\*NOTE\*** Specifications are subject to change without notice. Contact Pyxis ([service@pyxis-lab.com](mailto:service@pyxis-lab.com)) for an updated specification list.

| Item                 | SP-208 OXI-GO  |
|----------------------|--|
| P/N                  | 63068  |
| Low Chlorine Range   | 0.02-2.2mg/L (Free or Total Chlorine)                |
| High Chlorine Range  | 0.1-10.0mg/L (Free or Total Chlorine)                |
| Temperature Range    | 40 to 106 °F (4 to 41 °C)                            |
| Humidity             | 85% at 106 °F (41 °C)                                |
| Data storage         | 30,000 group data storage,<br>Bluetooth transmission |
| Dimension(L×W×H)     | 170×80×45mm(6.69×3.15×1.77 inches)                   |
| Display              | 320x240 TFT-LCD, visible under direct sunlight       |
| Cuvette/Sample Vial  | 10mL/24mm Diameter Cuvette (MA-24)                   |
| Weight               | 0.88lbs (400g without battery)                       |
| Power Supply         | 4 AA Alkaline Batteries                              |
| Typical Battery Life | 10,000 readings (480mAh battery)                     |
| Environmental        | IP67, dustproof and waterproof                       |
| Regulation           | CE / RoHS  |

| Item                        | pH & ORP module                            |
|-----------------------------|--|
| P/N                         | 50315                                      |
| pH Range †                  | 0–14                                       |
| pH Resolution               | ±0.01                                      |
| ORP Range                   | ±1,500 mV                                  |
| ORP Resolution              | ±1 mV                                      |
| pH/ORP Module ‡             | Wireless and replaceable – Sold Separately |
| pH/ORP Module Power Supply‡ | 1 ER14250 lithium thionyl chloride battery |

† With Automatic Temperature Compensation (ATC)

‡ Replacement recommended every 12–18 months



### 3 Unpacking the Instrument

Remove the instrument and accessories from the shipping container and inspect each item for any damage that may have occurred during shipping. Verify that all items listed on the packing slip are included. If any items are missing or damaged, please contact Pyxis Customer Service at [service@pyxis-lab.com](mailto:service@pyxis-lab.com).

#### 3.1 Standard Accessories

- AA (4) alkaline batteries
- Two (2) 10 mL Sample Vials, 24 mm diameter P/N: MA-24
- MA-NEB (1) Bluetooth/USB Adapter for use with uPyxis Desktop P/N: MA-NEB
- User manual available online at <https://pyxis-lab.com/support/>

#### 3.2 Optional Accessories

| Accessory Name   | P/N   |
|--|-------|
| Pyxis Handheld Hard Carrying Case for Handheld Devices   | 50725 |
| 10 ml Sample Vial- Replacement                           | MA-24 |
| Pyxis DPD Liquid Chlorine 1ppm Secondary Standard        | 21039 |
| Pyxis DPD Liquid Chlorine 2ppm Secondary Standard        | 21040 |
| Pyxis DPD - LR Chlorine Secondary Verification Kit       | 31102 |
| Pyxis DPD - HR Chlorine Secondary Verification Kit       | 31563 |
| pH & ORP Module - Bluetooth                              | 50315 |
| Battery for pH/ORP Module                                | 50778 |
| Pyxis pH/ORP Storage Solution— 70 mL                     | 63900 |
| Pyxis 200mV ORP Calibration Standard— 500 mL             | 57020 |
| Pyxis pH 4-7-10 Calibration Combination Kit— 500 mL each | 57007 |

### 3.3 Optional Reagents and HACH Cross Reference



| Method Name | Description    | Pyxis Reagent Name | Pyxis Reagent PN | Hach Reagent Name                         | HACH Reagent CAT # |
|-------------|----------------|--------------------|------------------|---|--------------------|
| Chlorine LR | Free Chlorine  | CL-F               | 31002            | DPD Free Chlorine Powder Pillows          | 21055-69           |
|             | Total Chlorine | CL-T               | 31014            | DPD Total Chlorine Reagent Powder Pillows | 21056-69           |
| Chlorine HR | Free Chlorine  | CL2HR              | 31015            | DPD Free Chlorine Powder Pillows          | 14070-99           |
|             | Total Chlorine | CL2THR             | 31060            | DPD Total Chlorine Reagent Powder Pillows | 14064-99           |

**\*NOTE\*** LR indicates the low-range test, HR indicates the high-range test.

## 4 Installation

### 4.1 Battery Installation

The SP-208 is powered by 4 AA alkaline batteries. The 4 AA alkaline batteries will last sufficient for approximately 10,000 measurements. When the battery capacity is critically low, the SP-208 will display a LOW BATTERY warning for 5 seconds and then automatically turn off. **\*IMPORTANT NOTE\***Do not use rechargeable nickel cadmium (NiCad) or lithium batteries. Replace the battery to resume operation of the SP-208 after the battery warning. The SP-208 will automatically turn on in the measurement mode after new battery installation.

The SP-208 battery compartment, shown in Figure 1, is on the back side of the instrument. Install battery as follows:

- Remove the battery compartment cover by loosening two screws.
- Make sure that snap the battery firmly into the battery holder.
- Replace the battery compartment cover, making sure that the sealing O-ring is lying flat on the battery compartment. To prevent the SP-208 from accidentally being turned on due to vibration, please firmly tighten the two screws. The 4 AA alkaline batteries will last sufficient for approximately 10,000 measurements. When the battery capacity is critically low, the SP-208 will display a LOW BATTERY warning for 5 seconds and then automatically turn off.

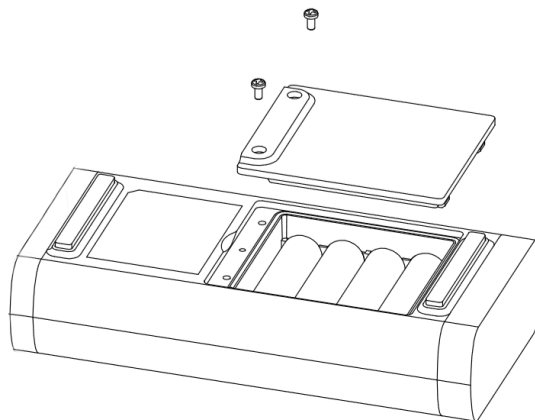

Figure 1 Battery Installation

## 4.2 pH/ORP Module Installation



Figure 2 pH/ORP Module

As mentioned at the end of section 1, the SP-208 can be upgraded to install the pH&ORP module with the purchase as an optional accessory. Pyxis offers a 6-month warranty on the pH/ORP module. Pyxis recommends replacing the module at a frequency of every 9–12 months as a best practice. Order a replacement pH/ORP module (P/N: 50315) from Pyxis at [order@pyxis-lab.com](mailto:order@pyxis-lab.com). If the module is turned on for 20 minutes a day, the module battery can last for about a year. The module indicator light will flash red if the module battery is low. Each replacement pH/ORP module will be shipped with a COC (Certificate of Calibration). The COC also includes an assigned Bluetooth MAC-Address for the new module. This MAC-Address will appear as an available device to pair the SP-208 main module to per the instructions below.

## 4.3 pH/ORP Module Installation Procedure

Follow the instructions below to install the **pH&ORP** module:

1. Power off the SP-208 by holding  .
2. Remove sample vial form the sample vial compartment.
3. Attach the **pH/ORP** module to the main module as shown in Figure 3.
4. To enable and Bluetooth pair the **pH/ORP** module, continue to the [8.0 section](#) and [8.3 section](#).

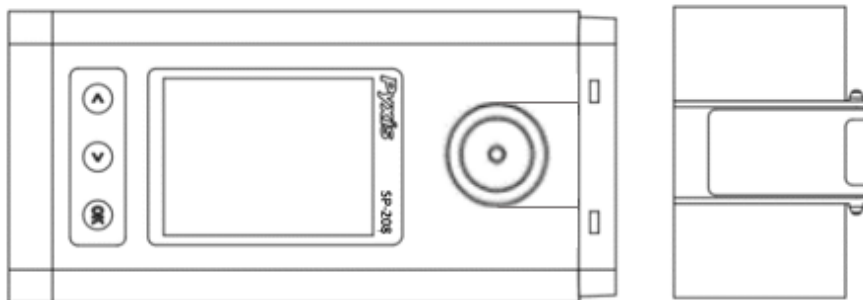

Figure 3

## 4.4 pH/ORP Module Battery Installation

The new pH/ORP module has a lithium thionyl chloride battery (3.7V-ER14250) installed. When the battery capacity is critically low and the main module displays a LOW BATTERY warning, replace the ER14250 battery. Use the following procedure to install a new battery:

1. Unsnap the pH/ORP module from the top of the main module.
2. Remove the battery compartment cover by using a coin or flat-head screwdriver to turn the cover counterclockwise.
3. Remove the old battery and dispose of it properly.
4. Following the orientation of the battery as shown in Figure 4, put a new ER14250 battery into the compartment.
5. Fasten the compartment cover by turning it clockwise.
6. Snap the pH/ORP module back atop the main module.

**\*NOTE\*** *Failure to properly fasten the cover may result in battery short-circuit and damage.*



Figure 4. Proper orientation of the ER14250 battery

## 5 Instruction Overview

### pH & ORP module Overview

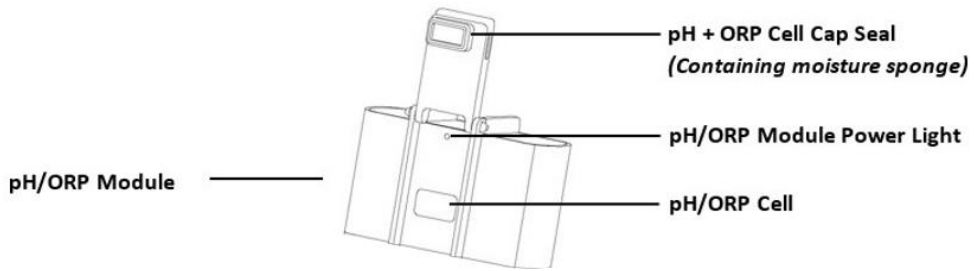

Figure 5

### Main module Overview

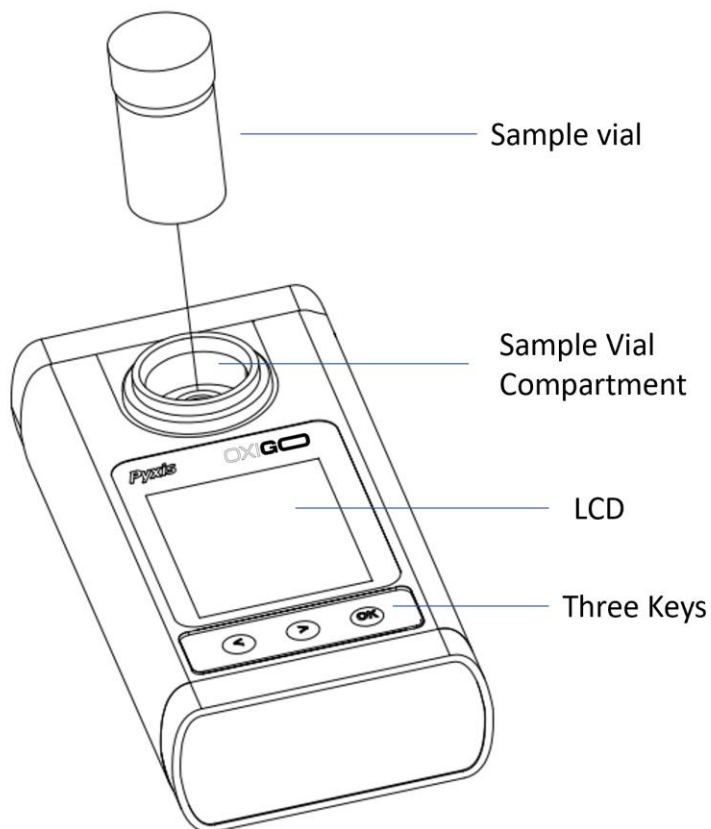

Figure 6

## 5.1 pH/ORP Cell Cap Seal



When the pH&ORP module is in storage, the pH/ORP Cell Cap Seal seals the pH/ORP cell, maintaining a moist environment for the electrodes. For vigorous field use, it is recommended to utilize a rubber-band to secure the pH/ORP Cell Cap Seal to prevent loss of pH/ORP Storage Solution.

The sponge soaked with the pH/ORP Storage Solution in the pH/ORP Cell Cap Seal helps prolong the life of the pH/ORP module. It may be discarded if desired, but pH/ORP Storage Solution must be maintained in the unit cell at all times during non-use. Please fill the pH/ORP cell with 1 mL of Pyxis pH/ORP Storage Solution (P/N: 63900) at all times when not using the pH/ORP cell.





Figure 7. pH/ORP Cell Cap Seal in the open position

## 5.2 Control Keys

The SP-208 has three control keys, as shown in Figure . The left (  ), right (  ), and ok (  ) keys are used to launch actions indicated on the LCD display directly above the keys. The labels above the keys indicate the function associated with each key and functions can be changed in different operation modes.

## 5.3 Main Module On/Off

To turn on the SP-208, press (  ) momentarily and release.

To turn off the SP-208, press and hold the (  ) key. Release the (  ) key when the LCD display turns off. The SP-208 turns itself off after 60 seconds without user interaction detected. This is done to conserve battery life. **\*NOTE\*** *The auto-time off setting may be customized by the user as desired through the uPyxis® Mobile or Desktop App or the Diagnosis interface.*

## 5.4 pH/ORP Module On/Off

The module is turned on by rotating the pH/ORP cell seal to touch the front face of the module as seen in [Figure 5](#). A sealed magnet within the rubber seal will trigger the module power circuit. The pH/ORP module will turn itself off when either commanded by the main module or automatically based on the default or customized idle time limit setting. The purpose for this design is to extend battery life. If pH/ORP measurement is not needed, the module does not need to be turned on.

## 6 Measurement

### 6.1 Switch Measurement Mode

The SP-208 only has one measurement mode when it leaves Pyxis factory (i.e., DPD free and total Chlorine mode). However, the measurement mode of SP-208 can be expanded with the purchase of a pH&ORP module. **\*Note\*** *The pH&ORP mode is disabled by default, refer to [section 8.0](#) to enable the pH&ORP mode.*

When powered on, the SP-208 defaults to Chlorine mode (Figure 8 and Figure 9). To switch from Chlorine mode to pH/ORP mode, press **Measure** (  ).



Figure 8 Chlorine mode-LR

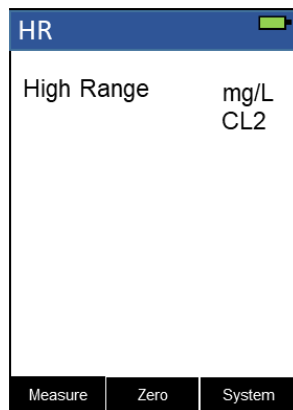

Figure 9 Chlorine mode-HR

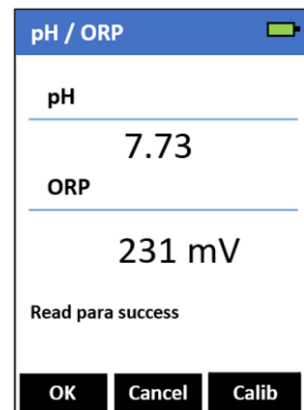

Figure 10 pH&ORP mode



## 6.2 DPD Free and Total Chlorine Measurement

### 6.2.1 Supported Methods

The SP-208 OXIGO™ is a unique pocket colorimeter specifically designed for measurement of free and total chlorine at low and high ranges (0.02–2.2ppm LR; 0.1–10.0ppm HR) in both Industrial & Municipal water treatment applications.

| Method Name | Description            | Range   |
|-------------|------------------------|---------|
| Chlorine LR | Low range, DPD method  | 2.2 ppm |
| Chlorine HR | High Range, DPD method | 10 ppm  |

### 6.2.2 Measurement Procedure

1. Press **Measure** (◀) to select the test range (Figure 8 and Figure 9).  
**LR** indicates the low-range test, **HR** indicates the high-range test.
2. Make the Blank sample by filling a sample vial with the water sample and place it in the sample vial compartment of the SP-208.
3. Press **Zero** (▶). **Zero** will then appear on the top-left corner of the display (**Error! Reference source not found.**).
4. Add the appropriate reagent to the Blank sample.
5. Make the Developed sample by capping the sample vial and inverting several times to fully mix the reagent and sample.
6. Place the Developed sample in the sample vial compartment SP-208.
7. Press **Read** (OK) to start the method timer (**Error! Reference source not found.**).
8. The SP-208 will continuously display the concentration as the timer counts down.  
Record the final value after timer stops (**Error! Reference source not found.**).

**\*NOTE\*** The rate of the reaction is often faster than the standard preset time. If the concentration remains stable on the concentration-time plot, press **Stop** (OK) to terminate the timing step early. The last concentration measurement will be displayed.

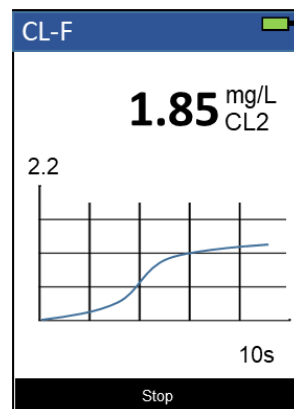
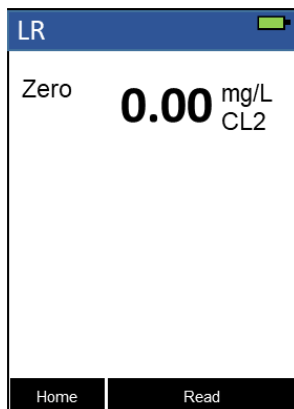

*Figure 11.*

*Figure 12*

## 6.3 pH/ORP Measurement

### 6.3.1 Measurement Procedure

**\*Precondition\*** when first using pH&ORP module, please enable and pair the pH/ORP module, refer to [8.0 section](#) and [8.3 section](#). Once completed, follow the steps below for pH&ORP measurements

1. Press **pH/ORP** (  ) to switch to the pH/ORP measurement mode. This will automatically power on the pH/ORP module. The indicator light of the module will be **green** and flashing when powered on. The main module of the SP-208 will automatically connect after the pH/ORP module has been powered up.
2. Once connected, the indicator light on the pH/ORP module itself will be change from green to **blue** and flashing. The prompt message is also changed from **Connecting...** to **Measuring...**
3. Once the measurements are completed, the values will be displayed and the prompt message will disappear.
4. Rinse the pH/ORP sample cell three times with the sample to be tested. Fill the sample cell with the sample.
5. The pH and ORP values will be updated every two seconds on the SP-208 main module display. The values will be displayed in white with a **blue background** once a stable value is reached (Figure 13).

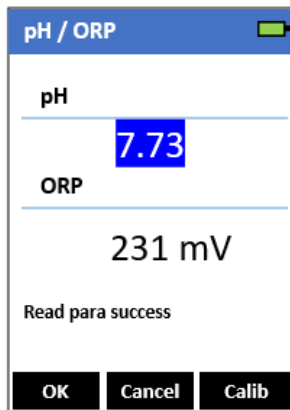

Figure 13.

### 6.3.2 Erroneous Values

An erroneous pH value could be obtained if the module has been stored dry without the protection of pH/ORP Storage Solution for a long period of time. In this case, please fill the module cell with pH/ORP Storage Solution to wet the electrode and allow it to soak for 30

minutes before use. If the pH/ORP Storage Solution is not available, please use the sample water to hydrate the electrode for at least 30 minutes.

### 6.3.3 pH Measurement Principle

The SP-208 pH/ORP module uses the standard electrochemical cell for the pH measurement. The cell consists of a glass electrode and an Ag/AgCl reference electrode. Potassium chloride (KCl) electrolyte filling gel is sealed in the Ag/AgCl electrode. The amount of reference electrolyte in the pH/ORP module is significantly larger than that used in a common laboratory pH electrode. This reduces the chance of the filling solution being diluted or contaminated and increases the electrode life.

The pH value is calculated from the measured cell potential ( $EMF$  in mV):

$$pH = \frac{EMF}{S(T) + pH_o} \quad (2)$$

$$S(T) = 0.1986(T + 273.15) \quad (3)$$

$S(T)$  in the above equation is the calibration slope, where  $T$  is temperature in degrees Celsius.  $S(T)$  has a theoretical value of 59.17 mV at 25 °C.  $pH_o$  is the calibration intercept. The calibration slope,  $S(T)$ , at the nominal temperature 25 °C and the intercept,  $pH_o$ , are determined in the two-point or three-point calibration procedure.  $pH_o$  is determined as well in the single-point pH 7.00 calibration. The temperature value measured by the pH/ORP module is used in the above equation to calculate the pH value at the sample temperature.

**\*NOTE\*** *The temperature compensation involved in the pH value calculation is quite different from that in the conductivity measurement. The temperature-compensated conductivity value is a would-be value at the reference temperature 25 °C, while the pH value displayed by the SP-208 is the true pH value at the sample temperature.*

### 6.3.4 ORP Measurement Principle

The SP-208 pH/ORP module measures the sample ORP with the platinum electrode and the Ag/AgCl reference electrode in the pH/ORP cell. The pH measurement and the ORP measurement share the same reference electrode. **Reporting an ORP value without specifying the reference scale has no meaning.** The value displayed by the SP-208 depends on the ORP value of the ORP standard used in the calibration. If the ORP value of the standard is referenced to the Standard Hydrogen Electrode (SHE), the ORP value reported by the SP-208 is SHE-based, i.e., in the unit of Eh. If the ORP value of the standard is referenced to the Ag/AgCl (3M KCl) electrode, the ORP value reported by the SP-208 is referenced to the same, commonly noted as (Ag/AgCl, 3M KCl).

The ORP electrode is calibrated using the Zobell's standard using the value of 221 mV at 25 °C before shipping. **The default ORP scale of the SP-208 before a user calibration is the Ag/AgCl (3M KCl).** If the SP-208 is exposed to an extremely high (> +600 mV) or extremely low (< -200 mV) ORP sample, rinsing the pH/ORP cell excessively when switching to measure a lower or higher redox buffer capacity sample is necessary. The dissolved oxygen in the sample can contribute to the ORP value measured. To measure a sample that has not been equilibrated with the ambient air, a slow and small upward drifting to more positive ORP value is normal. For a typical cooling water sample treated with oxidizing biocides, a  $\pm 20$  mV accuracy and  $\pm 10$  mV precision can be expected.

## 7 Calibration







### 7.1 Free & Total Chlorine Calibration

The method has been calibrated prior to shipping, there is no need to calibrate unless a calibration check indicates that the method needs a calibration. The following steps are used to calibrate a method:

Each method has been calibrated prior to shipping, there is no need to calibrate unless a calibration check indicates that the method needs a calibration. The following steps are used to carry out a slope calibration:

1. Fill a sample vial with a solution with known concentration and place it in the sample vial compartment of the SP-208.

**\*NOTE\*** For best results, the know concentration should be less maximum concentration of the method. See the **Supported Colorimetric Methods** table for concentration ranges for each method.

2. Complete a measurement with the desired method.
3. Press **Calib** (  ) to launch the calibration screen (Figure 14).
4. Press **OK** (  ) to start calibration (  ).
5. Use « (  ) and (  ) to adjust the concentration value to match the known concentration of the solution. (Figure ).
6. Press **OK** (  ) to start the calibration.
7. The message “Calibration succeeded” will appear on the display (Figure ).
8. Press **OK** (  ) to exit.

See following page for Calibration Screen Interface

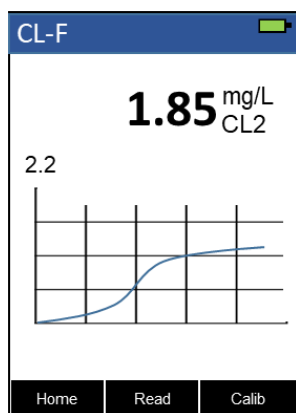

Figure 14

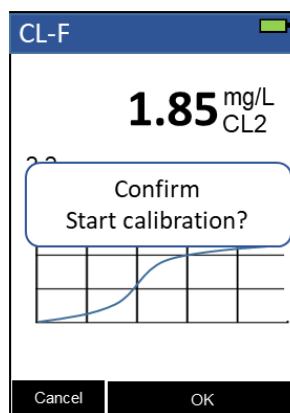

Figure 15

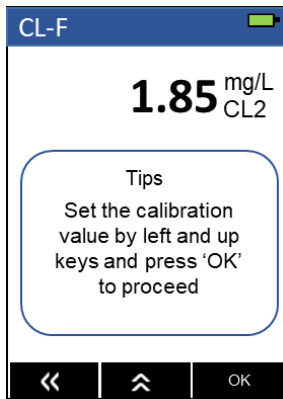

Figure 16

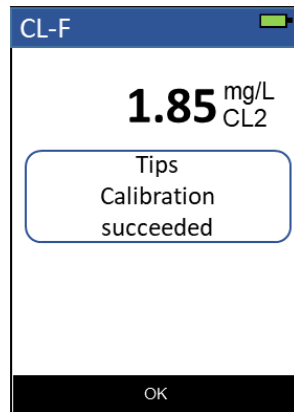





Figure 17

## 7.2 pH Calibration

The SP-208 is designed to provide a flexible calibration procedure. The user can start with the one-point pH7 calibration and progressively add a two- and three-point calibration with the pH4 and pH10 buffers. This allows the user to choose a procedure based on the need of measurement accuracy and the target pH range. Follow the steps below to conduct either a one-point, two-point, or three-point pH calibration:

1. Press **Measure** (  ) to switch the measurement mode to **pH/ORP** mode (Figure 13). This will automatically power on the pH/ORP module. The indicator light of the module will be **green** and flashing when powered on. The main module of the SP-208 will automatically connect after the pH/ORP module has been powered up.
2. Once connected, the indicator light on the pH/ORP module itself will be change from green to **blue** and flashing. The prompt message is also changed from **Connecting...** to **Measuring...**.
3. Once the measurements are completed, the values will be displayed and the prompt message will disappear.
4. Press **Calib** (  ) to show selection menu.
5. Press **Calib** (  ) as needed to highlight **pH** calibration in the selection menu (Figure 18).
6. Press **OK** (  ) to start the calibration procedure.

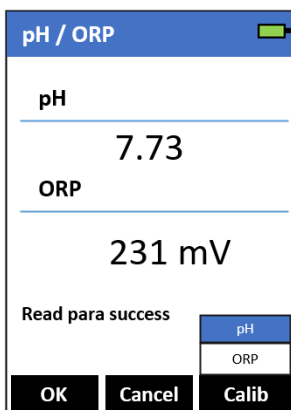















Figure 18.



### 7.2.1 One-Point Calibration

7. Rinse the pH/ORP sample cell three times with the pH7 buffer. Fill the sample cell with the pH7 buffer.
8. Allow 5–10 seconds for the pH measurement to stabilize and the padlock (  ) to appear.
9. Press **pH7** (  or  ) to start a one-point calibration.
10. If the calibration succeeds, a checkmark (  ) and a "pH7 Calibration success!" message will appear (Figure [19](#)). Otherwise, a warning message is displayed.
11. After a successful one-point calibration, choose one of two options:
  - (a) Press **Next** (  or  ) to proceed to a two- or three-point calibration, **or**
  - (b) Press **Exit** (  ) to end the calibration process at a one-point calibration.

### 7.2.2 Two-Point Calibration

12. Choose either the pH4 or pH10 buffer for a two-point calibration.
13. Rinse the pH/ORP sample cell three times with the chosen buffer. Fill the sample cell with the chosen buffer.
14. Allow 5–10 seconds for the pH measurement to stabilize and the padlock (  ) to appear.
15. Press **Calib** (  or  ) to start a two-point calibration.
16. If the calibration succeeds, a checkmark (  ) and a "pH4 Calibration success!" or a "pH10 Calibration success!" message will appear (Figure [20](#)). Otherwise, a warning message is displayed.
17. After a successful two-point calibration, choose one of two options:
  - (a) Press **Next** (  or  ) to proceed to a three-point calibration, **or**
  - (b) Press **Exit** (  ) to end the calibration process at a two-point calibration.

## 7.2.3 Three-Point Calibration

18. Use the remaining buffer (either the pH4 or pH10) for a three-point calibration.
19. Rinse the pH/ORP sample cell three times with the remaining buffer. Fill the sample cell with the remaining buffer.
20. Allow 5–10 seconds for the pH measurement to stabilize and the padlock (🔒) to appear.
21. Press **Calib** (⏪ or ⏩) to start a three-point calibration.
22. If the calibration succeeds, a checkmark (✔), a "pH4 Calibration success!" or a "pH10 Calibration success!" message, and a "Completed!" message will appear (Figure 21). Otherwise, a warning message is displayed.
23. After a successful three-point calibration, press **Exit** (⏪, ⏩ or OK) to return to pH/ORP mode.



Figure 19.



Figure 20.

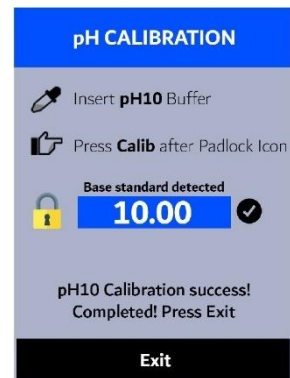

Figure 21.

### 7.3 ORP Calibration





The ORP scale of the SP-208 depends on the ORP scale of the calibration standard. For example, if the value of 220 mV for the common Zobell's standard at 25 °C is entered in the above calibration, the ORP value reported by the SP-208 after calibration is referenced to the Ag/AgCl(3M KCl) scale. This is because the value of 220 mV is based on the Ag/AgCl(3M KCl) reference electrode. If the value entered in the above calibration is 429 mV, the ORP value reported by the SP-208 is referenced to the SHE, because the value of 429 mV at 25 °C for the Zobell's standard is SHE based.





The values in the following table can be used to convert the Ag/AgCl reference electrode-based ORP value to the SHE-based ORP value. To obtain the SHE-based ORP value, add the number in the table to the corresponding Ag/AgCl reference electrode-based value. To use the table, the temperature of the standard solution measured by the SP-208 must be used.

| Temperature °F (°C)* | Ag/AgCl (1M KCl) | Ag/AgCl (3M KCl) | Ag/AgCl (saturation KCl) |
|----------------------|------------------|------------------|--------------------------|
| 68 (20)              | +234             | +213             | +202                     |
| 77 (25)              | +231             | +209             | +199                     |
| 86 (30)              | +228             | +205             | +196                     |

\* Use the temperature measured by the SP-208

Follow the steps below to carry out an ORP calibration:

1. Power on the SP-208 by pressing (  ).
2. Press **pH/ORP** (  ) to switch to the pH/ORP measurement mode. This will automatically power on the pH/ORP module. The indicator light of the module will be **green** and flashing when powered on. The main module of the SP-208 will automatically connect after the pH/ORP module has been powered up.
3. Once connected, the indicator light on the pH/ORP module itself will be change from green to **blue** and flashing. The prompt message is also changed from **Connecting...** to **Measuring...**.
4. Once the measurements are completed, the values will be displayed and the prompt message will disappear .
5. Press **Calib** (  ) to launch the **DEVICE INFORMATION** screen.
6. Press **Calib** (  ) as needed to highlight **ORP** calibration in the selection menu (Figure [22](#)).

7. Press **OK** (  ) to launch the **ORP CALIBRATION** screen (Figure [23](#)).
8. Use + (  ) and - (  ) to adjust the ORP value to match the ORP standard used.
9. Press **Calib** (  ). The message “Calibration Success” will appear on the display (Figure [24](#)).
10. ORP calibration is complete. Long press **Calib** (  ) to return to pH/ORP mode.

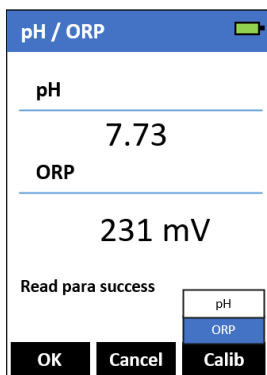

Figure 22



Figure 23

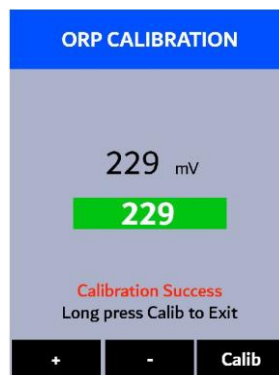

Figure 24

## 8. Device Information and Diagnosis

The **Information** screen is launched when System (OK) is pressed while not in an ongoing measurement procedure. This screen contains the device serial number, software version, and hardware version (Figure 25). The battery life as a percentage and the MAC addresses for main module also shown in 26 *Figure .*

Press **Set** (>) to launch the settings screen where can set the time, language, view the measurement log (Figure 6) and **enable pH&ORP module**.

**\*Note\* pH &ORP function is only available for SP-208 software version 159 and higher , please check your firmware version in DEVICE INFORMATION screen. See Section 9.4 for firmware upgrades if required.**

Press **Diag** (<) to launch the diagnosis screen where raw measurement data are displayed (Figure 25 *Figure*). The information has no use for normal operation, but instead is used for device troubleshooting. Provide an image of both the Information screen and the diagnosis screen when you contact [service@pyxis-lab.com](mailto:service@pyxis-lab.com) for troubleshooting your device or call +1 (866) 203-8397.

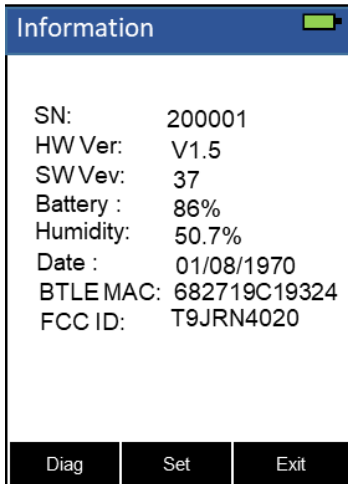

Figure 25

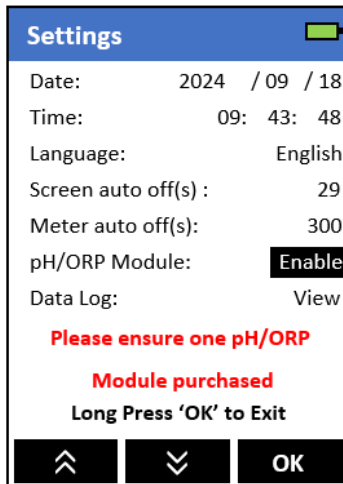

Figure 26

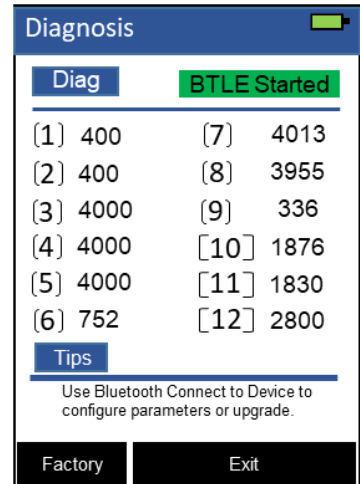

Figure 27

## 8.1 Bluetooth Connection to uPyxis® Mobile or uPyxis® Desktop App

The SP-208 uses a built-in Bluetooth Low Energy Connection (BTLE) to connect wirelessly to a smart phone via the **uPyxis®** Mobile App or to a computer via the included Bluetooth Adapter (P/N: MA-NEB) and the **uPyxis®** Desktop App. To allow the SP-208 to connect via Bluetooth with other devices follow the steps below:

1. Power on the SP-208 by pressing (OK).
2. Press **System** (OK) to launch the **Information** screen.
3. Press **Diag** (←) to launch the **Diagnosis** screen.
4. Allow 5–10 seconds for the message in the top-right corner of the display change from **Starting BTLE...** to **BTLE Started** (Figure 27).
5. Choose to connect via one of two options:
  - (a) The **uPyxis®** Mobile App ([see the Use with uPyxis® Mobile App section](#)), or
  - (b) The **uPyxis®** Desktop App ([see the Use with uPyxis® Desktop App section](#)).

## 8.2 Factory Reset

Use the following steps to restore all device parameters to factory default:

1. Power on the SP-208 by pressing (OK).
2. Press **System** (OK) as needed to launch the Information screen as show in figure25.
3. Press **Diag** (←) to launch the diagnosis screen. The display updates as shown in Figure 25 Figure.
4. Press **Factory** (←) .The display updates as show in Figure .
5. Press **OK** (OK) to start the factory reset.
6. The message “**Data recovery is successful**” will appear on the display (Figure ).

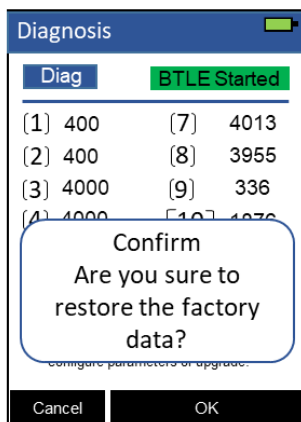

Figure 28

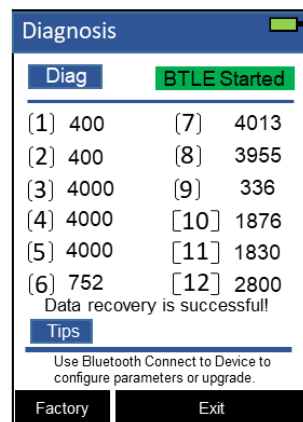

Figure 29

### 8.3 Bluetooth Paring to pH&ORP module

1. Power on the SP-208 by pressing ( **OK** ).
2. Make sure pH&ORP mode is enabled, refer to [see section 8.0](#).
3. Press **Measure** ( **<** ) to switch the measurement mode to **pH/ORP** mode(Figure 13).
4. Press **Comm** ( **>** ) to launch the **Bluetooth Paring** screen(Figure 30).
5. Press **Scan** ( **<** ) to begin scanning for Bluetooth devices.
6. Discoverable devices will begin to populate on the display with their name and MAC-Address (Figure 31).

**\* NOTE\*** To verify pairing to the correct pH/ORP module, the MAC-Address of the pH/ORP module can be found in its provided COC (Certificate of Calibration).

7. If more than one device appears in the **Device list**, press » ( **>** ) to cycle through the devices.
8. If no devices or the incorrect device appear in the **Device list**, press **Scan** ( **<** ) to re-scan for discoverable devices.
9. Press **Connect** ( **OK** ) to begin pairing to the selected device or long press Connect ( **OK** ) to exit.

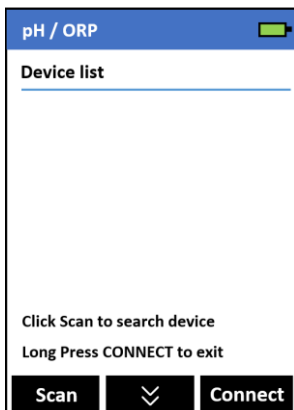

Figure 30

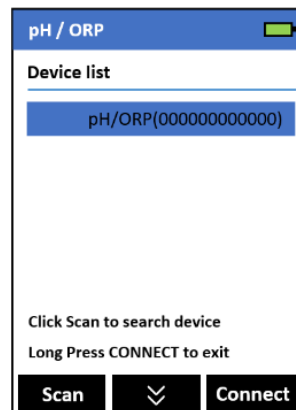

Figure 31

## 9 Use with uPyxis® 1.0 Mobile App

### 9.1 Download the uPyxis® 1.0 Mobile App

Download the uPyxis® 1.0 Mobile App from [Apple App Store](#) or [Google Play](#).



### 9.2 Connecting to the uPyxis® 1.0 Mobile App

Connect the SP-208 to a mobile smart phone according to the following steps:

1. Follow the steps in the **Bluetooth Connection to Devices** section to make the SP-208 discoverable.
2. Open **uPyxis®** Mobile App.
3. On **uPyxis®** Mobile App, pull down to refresh the list of available Pyxis devices.
4. If the connection is successful, the SP-208 and its Serial Number (SN) will be displayed ( [Figure 32](#) ).
5. Press on the **SP-208** image.



Figure 32



### 9.3 Setting Screen

From the **Setting** screen (Figure 31), the user can set the **Power off time** and **Screen off time** in seconds.

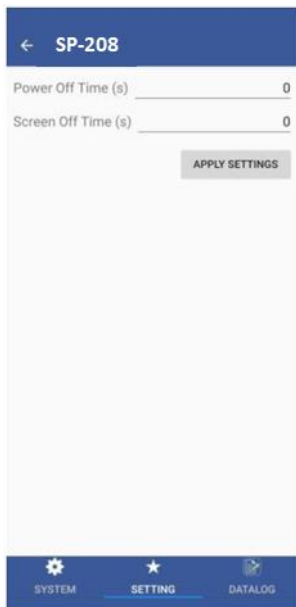

Figure 33



Figure 34

### 9.4 System Screen

When connected, the **uPyxis®** Mobile App will default to the **System** screen (Figure 34). From the **System** screen, users can change the **Device Name**, find the **Serial Number**, **Hardware Version**, and **Firmware Version**, as well as update the firmware of the SP-208 by pressing **Check Update**. If a firmware update is available, press **Get Firmware**. Once the new firmware is downloaded, press **Upgrade Firmware**. **\*NOTE\*** *The firmware update process takes some time and will require the SP-208 to stay within range (approximately 10 ft without obstructions) for the entire duration of the update.*

Once the update is complete, the SP-208 will reboot which will disconnect the SP-208 from the **uPyxis®** Mobile App.

## 9.5 Datalog Screen

From the **Datalog** screen, the user can view and export the internal log files of the SP-208 by pressing **Read Datalogs** and selecting the desired datalog (these are separated by month). The SP-208 will then populate any relevant log event from the selected datalog which can be viewed in more detail by pressing **Read Record** or exported as a CSV document by pressing **Export/Share**.

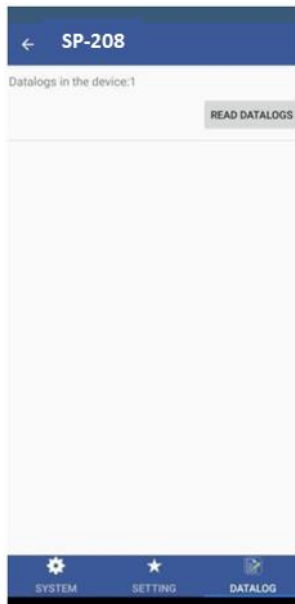

Figure 35

## 10 Use with uPyxis® Desktop App

### 10.1 Install uPyxis® Desktop App

Download the latest version of **uPyxis®** Desktop software package from: <https://pyxis-lab.com/upyxis/> this setup package will download and install the Microsoft.Net Framework 4.5 (if not previously installed on the PC), the USB driver for the MA-NEB USB-Bluetooth adapter (P/N: MA-NEB) and the main **uPyxis®** Desktop application. Double click the **uPyxis.Setup.exe** file to install.

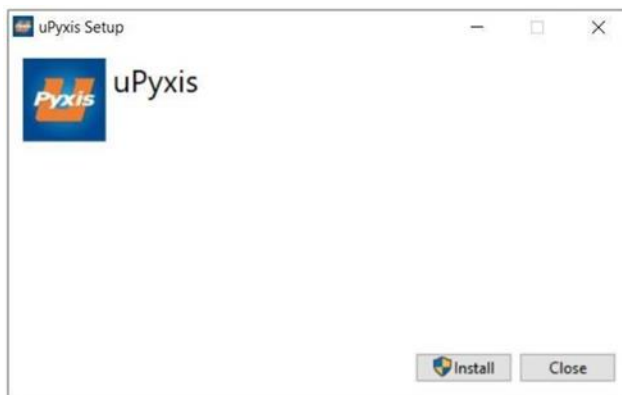

Figure 36

Click **Install** to start the installation process. Follow the screen instructions to complete the USB driver and uPyxis installation.

### 10.2 Connecting to uPyxis® Desktop App

Connect the SP-208 to a Windows computer using a MA-NEB Bluetooth/USB adapter (P/N: MA-NEB) according to the following steps:



1. Follow the steps in the **Bluetooth Connection to Devices** section to make the SP-208 discoverable.
2. Plug the Bluetooth/USB adapter into a USB port in the computer.
3. Launch **uPyxis®** Desktop App.
4. On **uPyxis®** Desktop App, click Device → **Connect via USB-Bluetooth** (37).
5. If the connection is successful, the SP-208 and its Serial Number (SN) will be displayed in the left pane of the **uPyxis®** window.



Figure 37

### 10.3 System Screen

Once connected to the device, a picture of the device will appear on the top-left corner of the window and the **uPyxis®** Desktop App will default to the **System** screen. From the **System** screen, users can upgrade the firmware by selecting an appropriate firmware file (contact [service@pyxis-lab.com](mailto:service@pyxis-lab.com) for these firmware files) and clicking **Upgrade Firmware**.

**\*NOTE\*** *The firmware update process takes some time and will require the SP-208 to stay within range (approximately 10 ft without obstructions) for the entire duration of the update*

Once the update is complete, the SP-208 will reboot which will disconnect the SP-208 from the **uPyxis®** Mobile App.

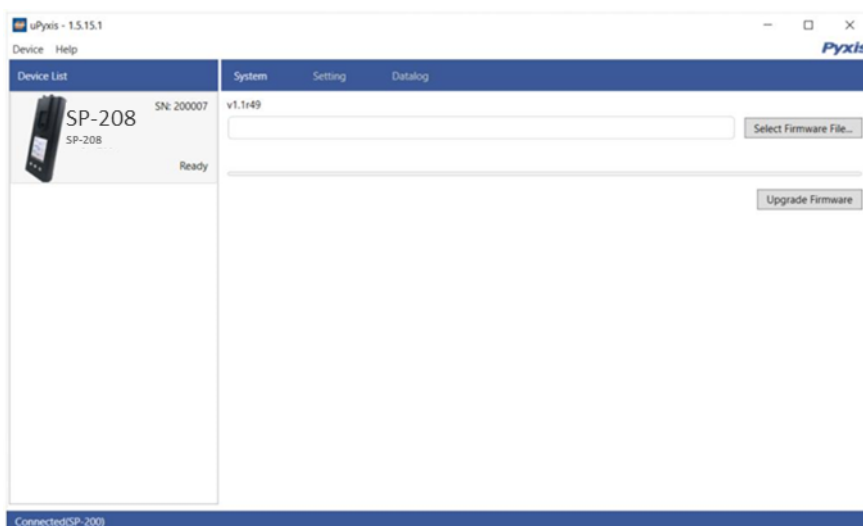

Figure 38

## 10.4 Setting Screen

From the **Setting** screen, the user can set the **Power off time** and **Screen off time** in seconds.

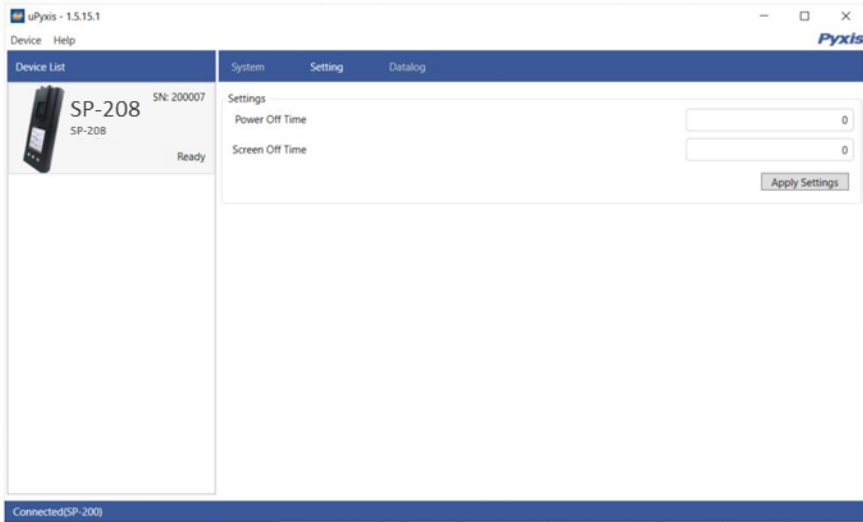

Figure 39

## 10.5 Datalog Screen

From the **Datalog** screen, the user can view, delete, and export the internal log files of the SP-208 by clicking **Read Datalog List** and selecting the desired datalog (these are separated by month). The SP-208 will then populate any relevant log event from the selected datalog which can be viewed in more detail by clicking **Read Datalog**, deleted by clicking **Delete**, or exported by clicking **Export as .CSV File**.

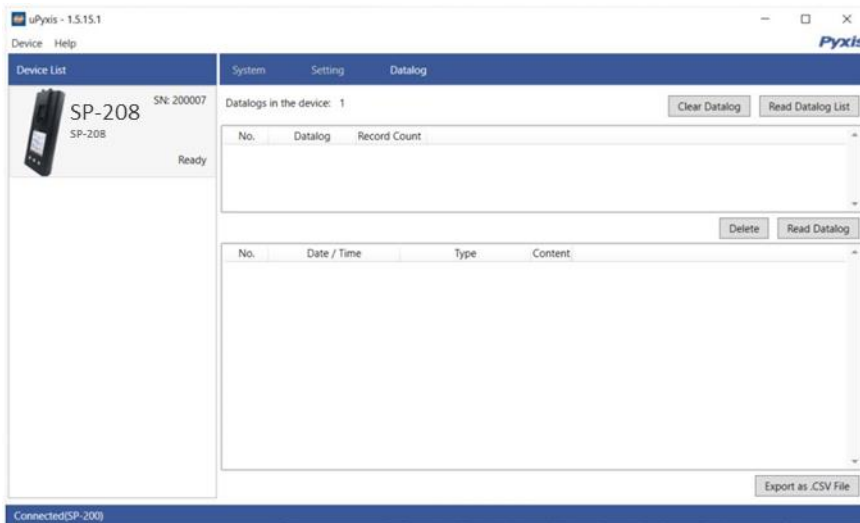

Figure 40

## 11 Device Maintenance and Precaution

### 11.1 Maintenance Best Practices and Quick Tips

For greatly increased working life and ease of use of the SP-208 follow the list of maintenance best practices and quick tips below:

- Use a soft cloth or lint free paper tissue to clean the sample vial compartment periodically. Remove debris, scale, and deposit promptly.
- Although the SP-208 is protected from water damage, it is a good practice to avoid water entering the sample vial compartment. Deposits left behind when the water is evaporated could affect performance.
- During storage and transportation, do not leave a sample vial in the sample vial compartment.
- Replace batteries when the SP-208 displays a warning message indicating LOW BATTERY voltage. Remove batteries from the SP-208 battery compartment if the SP-208 is going to be placed in storage for a long period time.
- Replace the MA-24 (10mL) sample vials if excessive scratching or staining. Always orient the vials properly during device use.
- When the SP-208 is shipped, a desiccant pack is included in the desiccant compartment underneath the cover of the battery compartment. It is recommended that a new desiccant pack is replaced each time the batteries are replaced.

### 11.2 Storage

The SP-208 should be stored in the temperature range of 0–140 °F (-18–60 °C) and relative humidity less than 85% at 106 °F (41 °C). Do not leave the SP-208 in a parked vehicle as the temperature inside can reach above 150 °F in summer and -20 °F in winter. Remove batteries from the SP-208 battery compartment when in storage for a long period time. Do not leave a sample vial in the sample vial compartment.

When the pH/ORP cell is not in use, fill the cell with 1 mL of Pyxis pH/ORP Storage Solution (P/N: 63900) and ensure the pH/ORP cell seal is closed completely. The pH/ORP cell seal maintains a moist environment for the electrodes. For vigorous field use, it is recommended to utilize a rubber-band to secure the pH/ORP cell seal to prevent loss of pH/ORP Storage Solution.

## **12 Contact Us**

**Pyxis Lab, Inc**

21242 Spell Circle

Tomball, Tx 773756 USA

[www.pyxis-lab.com](http://www.pyxis-lab.com)

Phone: +1 (866) 203-8397

Email: [service@pyxis-lab.com](mailto:service@pyxis-lab.com)