



LSR-803 Series Level Sensors

Radar Level Sensors with Display, Data Log, Battery Power & LoRa



Pyxis Lab® Inc.

21242 Spell Circle
Tomball, TX 77375
www.pyxis-lab.com

USER MANUAL



The information contained in this manual may be confidential and proprietary and is the property of Pyxis Lab, Inc. Information disclosed herein shall not be used to manufacture, construct, or otherwise reproduce the goods described. Information disclosed herein shall not be disclosed to others or made public in any manner without the express written consent of Pyxis Lab, Inc.

Limited Warranty

Pyxis Lab warrants its products for defects in materials and workmanship. Pyxis Lab will, at its option, repair or replace instrument components that prove to be defective with new or remanufactured components (i.e., equivalent to new). The warranty set forth is exclusive and no other warranty, whether written or oral, is expressed or implied.

Warranty Term

The Pyxis warranty term is thirteen (13) months ex-works. In no event shall the standard limited warranty coverage extend beyond thirteen (13) months from the original shipment date.

Warranty Service

Damaged or dysfunctional instruments may be returned to Pyxis for repair or replacement. In some instances, replacement instruments may be available for short duration loan or lease.

Pyxis warrants that any labor services provided shall conform to the reasonable standards of technical competency and performance effective at the time of delivery. All service interventions are to be reviewed and authorized as correct and complete at the completion of the service by a customer representative or personnel. Pyxis warrants these services for 30 days after the authorization and will correct any qualifying deficiency in labor provided that the labor service deficiency is exactly related to the originating event. No other remedy, other than the provision of labor services, may be applicable.

Repair components (parts and materials), but not consumables, provided during a repair, or purchased individually, are warranted for 90 days ex-works for materials and workmanship. In no event will the incorporation of a warranted repair component into an instrument extend the whole instrument's warranty beyond its original term.

Warranty Shipping

A Repair Material Authorization Number (RMA) must be obtained from Pyxis Technical Support before any product can be returned to the factory. Pyxis will pay freight charges to ship replacement or repaired products back to the customer. The customer shall pay freight charges for returning products to Pyxis. To receive an RMA you can generate a request on our website at <https://www.pyxis-lab.com/request-return-or-repair/>

Pyxis Technical Support

You can contact Pyxis Technical Support at 1-866-203-8397 or service@pyxis-lab.com

Table of Contents

1.	Introduction.....	4
2.	Specifications.....	4
3.	Unpacking Instrument.....	5
3.1	Standard Provided Accessories.....	5
3.2	Optional Accessories.....	5
4	Installation.....	6
4.1	Battery Installation or Replaced	6
4.2	Wiring.....	7
4.3	Tank Top Installation and Precautions.....	8
5	Instrument Overview	13
5.1	LED Indicators	13
5.2	Function Button	14
5.3	OLED Display	15
6	Setup with uPyxis 2.0 Mobile & Desktop Apps	16
6.1	Download uPyxis 2.0 Mobile App	16
6.2	Connecting to uPyxis 2.0 Mobile App	16
6.3	Parameter Setting via uPyxis Mobile App.....	17
6.4	Install uPyxis Desktop App	19
6.5	Connecting to The uPyxis Desktop App	19
6.6	Parameter Setting via uPyxis Desktop App.....	21
6.7	4-20 mA Output Setup.....	24
7.	Communication Using Modbus RTU	25
8.	Communication Using LoRa (<i>For LSR-803L Only</i>)	25
9.	Application	25
9.1	Filling reagent into tank	25
9.2	Monitoring reagent consumption.....	26
10.	Sensor Maintenance and Precaution	26
11.	Regulatory Approval	27
	Contact Us.....	27

1. Introduction

The Pyxis LSR-803 Series sensors are W-band FMCW continuous frequency modulation radar level transmitters. They provide continuous level measurement up to 591 inches (49.2 ft. or 15 m) with 4-20 mA output as well as RS485 and BlueTooth 5.0®. The LSR-803L is also equipped with LoRa (Long Range Radio) digital output for long-distance wireless level sensor data access. The LSR-803 Series has a 1.3" OLED display and 4 buttons for quick configuration and can be wirelessly configured via the Pyxis **uPyxis**® app for Mobile or Desktop devices enabling rapid integration and deployment in the field. The sensors are powered by a 24 VDC / 2.0W external power supply or 4-AA alkaline batteries and are ideal for use with commonly used OEM controllers, PLC or DCS systems. This non-contact liquid level sensor platform is well suited for corrosive liquids and can be used for industrial, municipal and process liquid storage as well as chemical feed applications.

2. Specifications

Specification	LSR-803L	LSR-803
Part Number (P/N)	54495	50191
Power Supply	24 VDC, 2.0W Max -or- 4x AA alkaline batteries	24 VDC, 2.0W Max -or- 4x AA alkaline batteries
BlueTooth® Connectivity	BlueTooth 5.0® 4.1, 32 ft. (10 Meters) Line of Sight for use with uPyxis	
Radio Output	Long Range Radio (LoRa)	None
Wired Output	1x 4-20mA / RS-485 MODBUS	
Output Cable	Waterproof 7-Pin (10ft / 3m) Cable with Adapter & Flying Lead	
Extension Cable	Waterproof Extension Cables Sold Separately	
Range	2 – 591 inches (0.05 – 15 meters)	
Resolution	0.02 inch (0.5 mm)	
Accuracy	±2mm	
Dead Zone	2 inch (5 cm)	
Measurement Interval	Programmable via uPyxis in both 24VDC or AA battery power source	
Installation	2-inch NPT	
Weight	0.82 pound (370 g)	
Dimension	Height: 4.13 inch (105 mm); Diameter: 3.31 inch (84 mm)	
Enclosure Material	Polycarbonate (PC), Polybutylene Terephthalate (PBT)	
Ambient Temperature	5 - 122 °F (-15 - 50 °C)	
Storage Temperature	-4 - 140 °F (-20 - 60 °C)	
Pressure	-29 – 58 PSI (-0.2 – 0.4 MPa)	
Enclosure Rating	IP66	IP67
Display	1.3" OLED display	
Regulation	UL / CE / RoHS / UKCA	
Transmitter FCC ID	2BAJ2-LSR	

**With Pyxis' continuous improvement policy, this specification is subject to change without notice.*

3. Unpacking Instrument

Remove the instrument and find the standard accessories from the shipping container as listed below. Inspect each item for any damage that may have occurred during shipping. Verify that all accessory items are included. If any item is missing or damaged, please contact Pyxis Lab Customer Service at service@pyxis-lab.com or by phone at 1-866-203-8397.

3.1 Standard Provided Accessories

The LSR-803 Series level sensors as delivered are provided with the items outlined below.

- **LS-803L** Radar Level Sensor with LoRa (P/N 54495)
 - One **MA-L10** Waterproof 7-Pin Cable with Adapter & Flying Leads (10ft /3m)
- **LS-803** Radar Level Sensor (P/N 50191)
 - One **MA-L10** Waterproof 7-Pin Cable with Adapter & Flying Leads (10ft /3m)
- User Manual Can Be Downloaded at [Support Documents - Pyxis Lab, Inc. \(pyxis-lab.com\)](http://Support Documents - Pyxis Lab, Inc. (pyxis-lab.com))

3.2 Optional / Replacement Accessories

The following optional or replacement accessories are available for use with LSR-803 Series level sensor platform and are sold separately.

Optional Accessory Name / Description	P/N
MA-L10 <i>(10-ft Flying Lead Cable with 7Pin Waterproof Adapter)</i>	MA-L10
MA-L50 <i>(50-ft Extension Cables with 7Pin Waterproof Adapters)</i>	MA-L50
MA-L100 <i>(100-ft Extension Cables with 7Pin Waterproof Adapters)</i>	MA-L100
MA-AC-7US <i>(110VAC-24VDC Power Supply Adapter – 7Pin Waterproof – USA Plug)</i>	26398
MA-AC-7EU <i>(230VAC-24VDC Power Supply Adapter – 7Pin Waterproof – EU/DIN Plug)</i>	28787
LSR-MB-A001 <i>(2-inch PVDF Well Insert Vapor Barrier for LSR Sensors use with Amine / Ammonia)</i>	21290
LSR-MB-W001 <i>(LSR Series – Wall Mounting Bracket Kit Wall Mounting Installs)</i>	24658
LSR-MB-H002 <i>(LSR -803 Series – Hanging Mounting Bracket Kit Suspended Installs)</i>	29634
LSR-MB-B001 <i>(LSR Series – Belt Mounting Bracket Kit for Totes & Tank Strap Installs)</i>	23220
LG-100 <i>(LoRa Receiver & 4-20mA/RS-485 Converter for use with Pyxis Sensors)</i>	28903

4 Installation

4.1 Battery Installation or Replaced

The LSR-803 series sensor may be powered by four (4) AA alkaline batteries if not being used in a 24 VDC powered format from a controller. It is very important that you do not use rechargeable nickel cadmium (NiCad) or lithium batteries. Typical AA alkaline battery life after replacement is approximately 6 based on data logging/measurement frequency of once per hour as programmed by the user in the uPyxis APP. When using AA batteries, it is important to never program the sensor for continuous measurement. If this is done, battery life will be greatly diminished to about 3 weeks. Please refer to the LSR-803/803L battery compartment as shown in Figure 1.

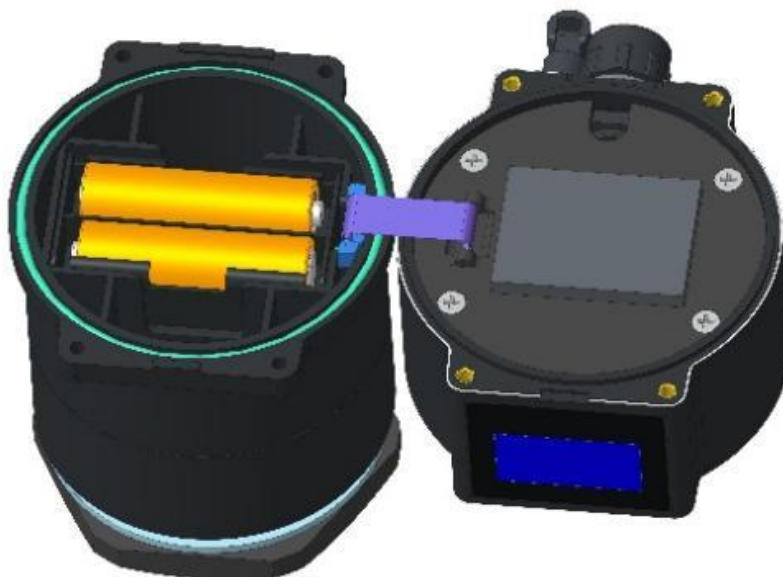

Figure 1. Open the battery compartment.

Install or replace the AA batteries as follows:

1. Remove the battery compartment cover by loosening four screws. Pay attention to the connection wire between the two parts when separated as to not cause damage.
2. Follow the positive and negative signs in the battery compartment and insert batteries firmly into the battery holder.
3. Replace the battery compartment cover, making sure that the sealing O-ring is lying flat on the battery holder. Failure to do so may result in water/moisture damage to the meter. To prevent the LSR-803/803L from accidentally being turned on or off due to vibration, please firmly tighten the four screws.

4.2 Wiring

The LSR-803 Series level sensors can be powered by a 24V DC power supply from any standard controller, PLC or DCS. The sensors offer both 1x 4-20mA and 1x RS-485 Modbus outputs. The 24V DC negative (black wire) and 4-20mA- wire are internally connected from the LSR-803 Series sensor therefore it is unnecessary to connect the green to the 4-20 mA negative terminal in the controller. If a separate DC power supply other than from a controller is used, make sure that the output from the power supply is rated for 22-26 VDC @ 100mA. Under standard installations the clear wire is not landed and remains unused.

NOTE *Pyxis recommends powering off the controller when landing wires to the controller terminal board while the adapter to LSR-803 series sensor is connected. Follow the wiring table below to connect the sensor to a controller or receiving device.*

Wire Color	Designation
Red	24 V +
Black	24 V Power ground
White	4-20 mA +
Green	4-20 mA -
Blue	RS-485 A
Yellow	RS-485 B
Clear	Shield, earth ground

NOTE *If LSR-803 Series level sensors are powered by 4x AA alkaline batteries, users can obtain the level information from sensors without wiring via LoRa or Bluetooth and RS485 Modbus. The 4-20mA signal output is not available in the AA battery-powered mode.*

4.3 Dimensions

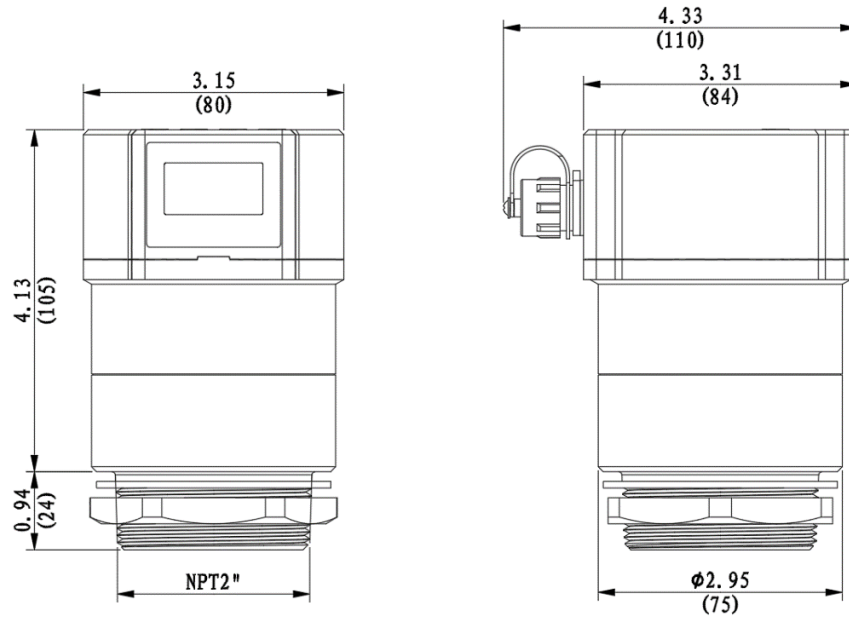

LSR-803 Dimension

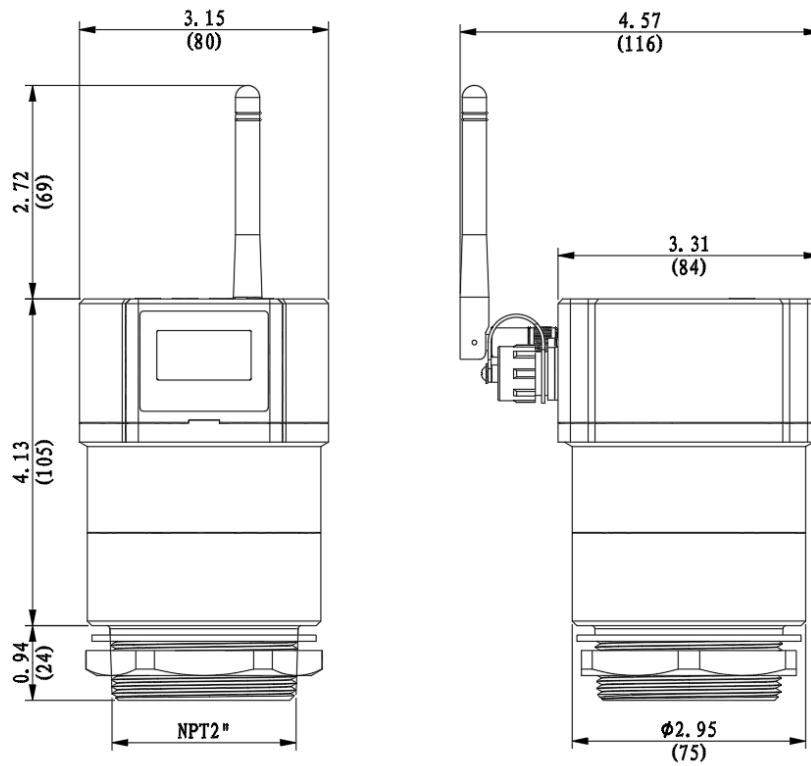

LSR-803L Dimension

Figure 2. LSR-803 Series Dimensions, inch (mm)

4.4 Tank Top Installation and Precautions

Should the sensor be installed in a 2-inch bulkhead fitting on the top of the tank, the following installation guideline should be maintained. The dimensions of the LSR-803 and LSR-803L sensors are shown in Figure 3. If a flat horizontal surface is not available on the top of the tank, please use a self-aligning bulkhead fitting so that the sensor can be adjusted to be perpendicular (90°) to the liquid surface. The LSR-803 series sensors are also embedded with a 3-axis accelerometer which allows the user to use the Display Mode Switch Button to get the Z-axis angle (the angle at which the sensor deflects the line of gravity) measurement result, just as shown below. In other words, Z angle represents the inclination of the horizontal plane of the sensor. In order for the sensor to work properly, the Z angle should be measured within 3 degrees of 0.00 horizontal baseline.

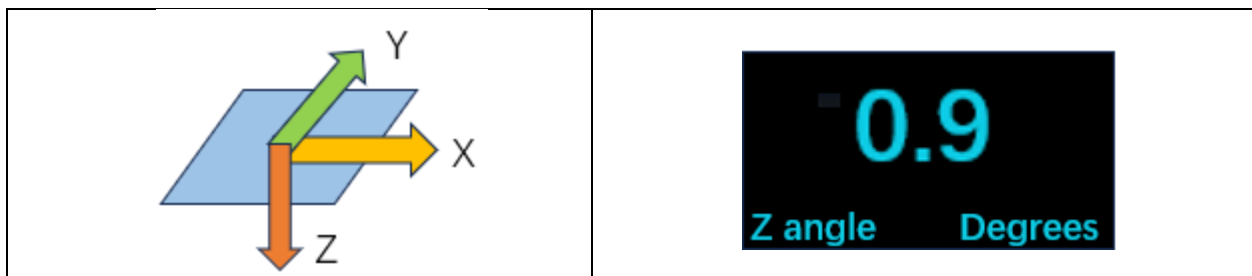

- Install and adjust the sensor to be perpendicular to liquid surface.
- Installation location should not be too close to container wall to avoid interference.
- The sensor has a 1.97 inch (5 cm) dead zone (DZ). Raise the probe to avoid the DZ as needed.
- Do not install in a location which will cause the microwave to be obstructed.

Top of Tank Installation Suggestions

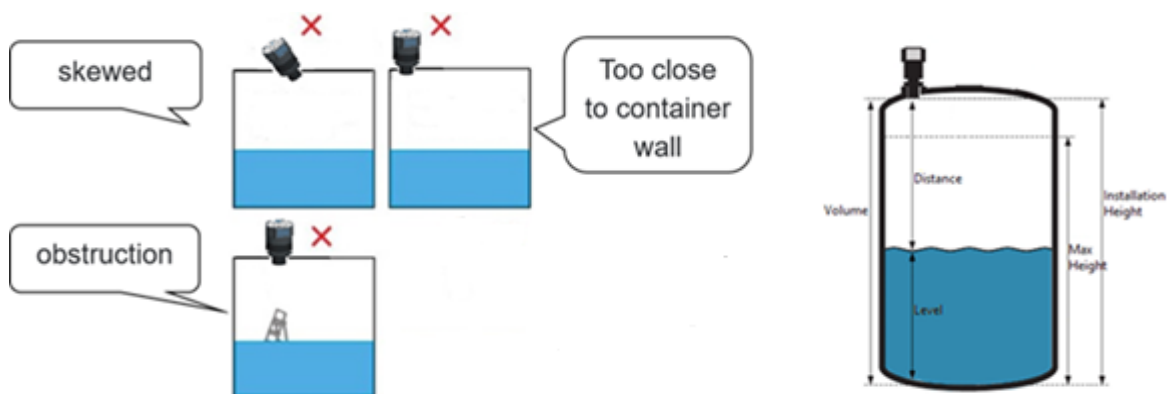

Figure 3. LSR-803 Series Installation Illustration

4.5 LSR Mounting Kit Installations

The following mounting kits are available as optional accessories (sold separately) for a variety of installation formats, ideal for portable/replaceable tank and drum liquid level monitoring. For the LSR Series Mounting Kit Installation Guide please contact service@pyxis-lab.com

WALL Mount Kit

- LSRMB-W001 (P/N 24658)
- Wall Mounting for LSR-803 Series



Mount to Wall

Adjustable Angle

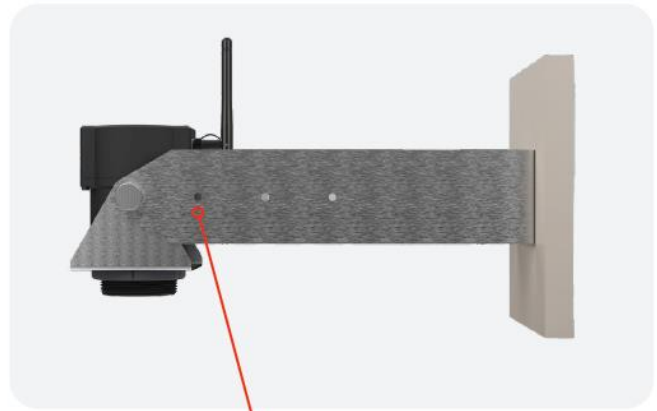

Adjustable Distance

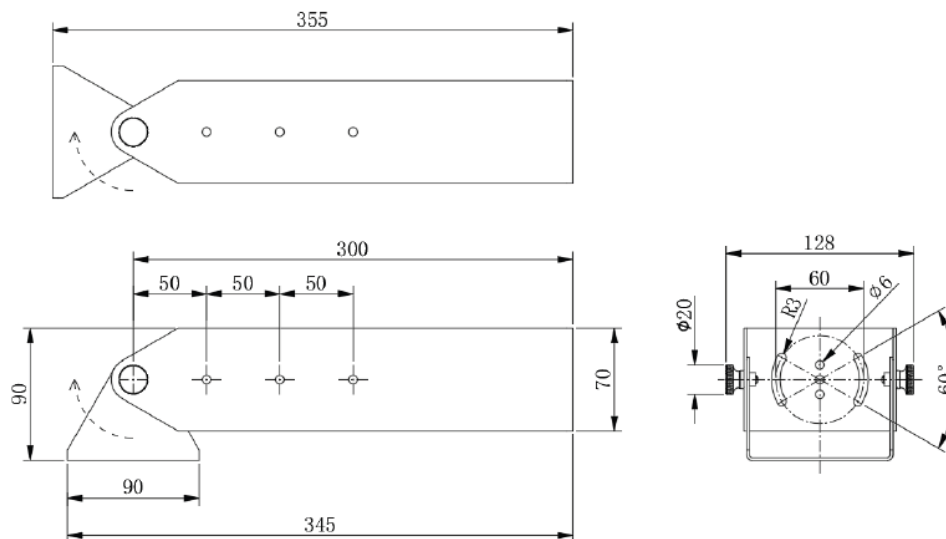

HANGING Mount Kit

- **LSRMB-H002** (P/N 29634)
- Hanging (Suspended) Mounting for LSR-803 Series

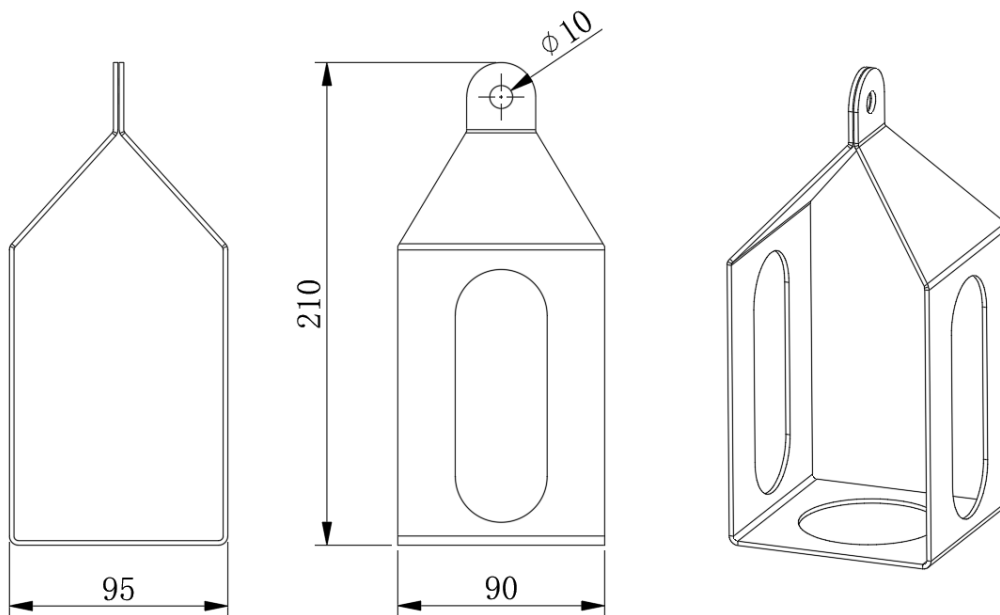

BELT Mount Kit

- **LSRMB-B001** (P/N 23220)
- Belt Mounting for LSR-803 Series on Drum or Tote

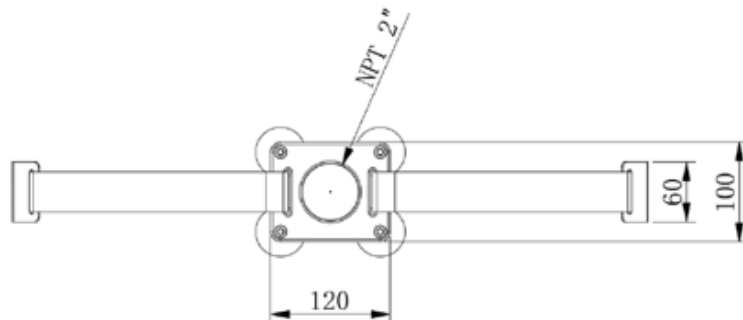
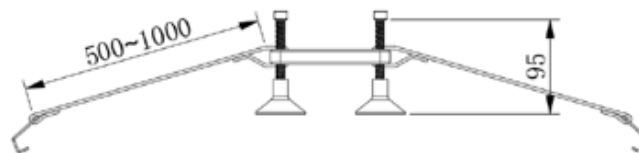

5 Instrument Overview

5.1 LED Indicators

The LED indicators on the top of the sensor (Figure 4) are used to indicate sensor status and BlueTooth 5.0® connection status.

LED Status	ON	OFF
Green LED	Power Supply is ON and Sensor is running	Power Supply is OFF or in Sleep Mode
Blue LED	BlueTooth 5.0® is connected	BlueTooth 5.0® is disconnected



Figure 4. Sensor Connection and LED Indicators

5.2 Function Button

 Power Button:

- **Power On:** Hold the power button for 1 second.
- **Power Off:** Hold the power button until the Power Status Indicator blinks.
- **Display Wakeup:** Hold the power button for 1 second to relight OLED display (Only power button has this function)

NOTE: Power On/Off function is only for Battery-Powered mode, if external 24V power supply is used, the sensor will power up automatically.

 **Working Mode Switch Button:** Hold switch button to switch the probe working mode. Working mode includes Continuous Measurement Mode, Period Measurement Mode and Stop Mode. The default periods include 30 seconds / 5 minutes / 1 hour / 8 hours / 24 hours or a custom time period also can be set by the user in the uPyxis APP. The set working mode will be displayed on the right corner of OLED screen.

 **Display Mode Switch Button:** Press the button until the expected information is displayed. Information display includes All-In-One Display, Single Measurement Result Display and Product Related Information Display.









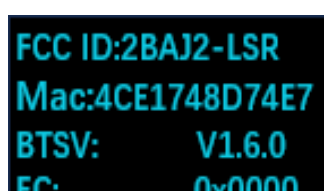

 **Bluetooth Mode Switch Button:** Press the button until the expected working mode is active. Bluetooth working modes include P-Peripheral (Connectable) Mode, B-Beacon (Broadcast) Mode and Shutdown Mode. The current working mode will be displayed on the OLED.

B = BEACON MODE (For Tank Level Visibility Only)

P = PERIPHERAL MODE (For All Tank Level Data & Configuration / Setup Interface)

NO BLUETOOTH SIGN = SHUTDOWN MODE (No Wireless Communication)

5.3 OLED Display Symbols & Definitions

OLED EXAMPLES	SYMBOL	DEFINITION
   		Battery Status
	CONT	Continuous Working Mode
		Connectable (Peripheral) Mode
		Bluetooth is Connected
		Bluetooth Mode In Switching
	P	Connectable (Peripheral) Mode
	B	Broadcast (Beacon) Mode
	Lvl	Liquid Level Surface Height
	Dst	Distance Between Liquid Surface and Probe Surface
	Vol	Remaining Liquid Volume
		Sensor is Registering to LoRa Gateway
		LoRa Registration Completed
		Strength Indicator of Received Radar Echo Signal
	gal	Gallon
	1.0h	Measurement Interval = 1 Hour
	in	Inches
FULL	Liquid Level Reaches Highest Setting Value	
Mac	Product MAC Address	
BTSV	Bluetooth Product Firmware	
FCC	Federal Communications Commission	
EC	Error Code	
<p>NOTE - The LSR-803 series contains Transmitter Module FCC-ID:2BAJ2-LSR</p>		

6 Setup with uPyxis 2.0 Mobile & Desktop Apps

6.1 Download the uPyxis 2.0 Mobile App

Download **uPyxis 2.0** Mobile APP from Apple [App Store](#) or [Google Play](#).



6.2 Connecting to uPyxis 2.0 Mobile App

Turn on the BlueTooth 5.0® on in your mobile device. ***NOTE*** Do not pair the phone's BlueTooth 5.0® to the LS-803 series sensor, the uPyxis 2.0 APP will do the pairing.

NOTE Make sure the LSR-803 series is in Peripheral (P) Mode if you desire to configure the sensor. For tank level reading only, the unit may remain in Beacon (B) Mode.

Open uPyxis 2.0 Mobile App. Click "Scan Bluetooth" button and the App will start to search for Pyxis sensors. Click on the [LS-803L Sensor Picture](#) to connect to the Pyxis Radar sensor.

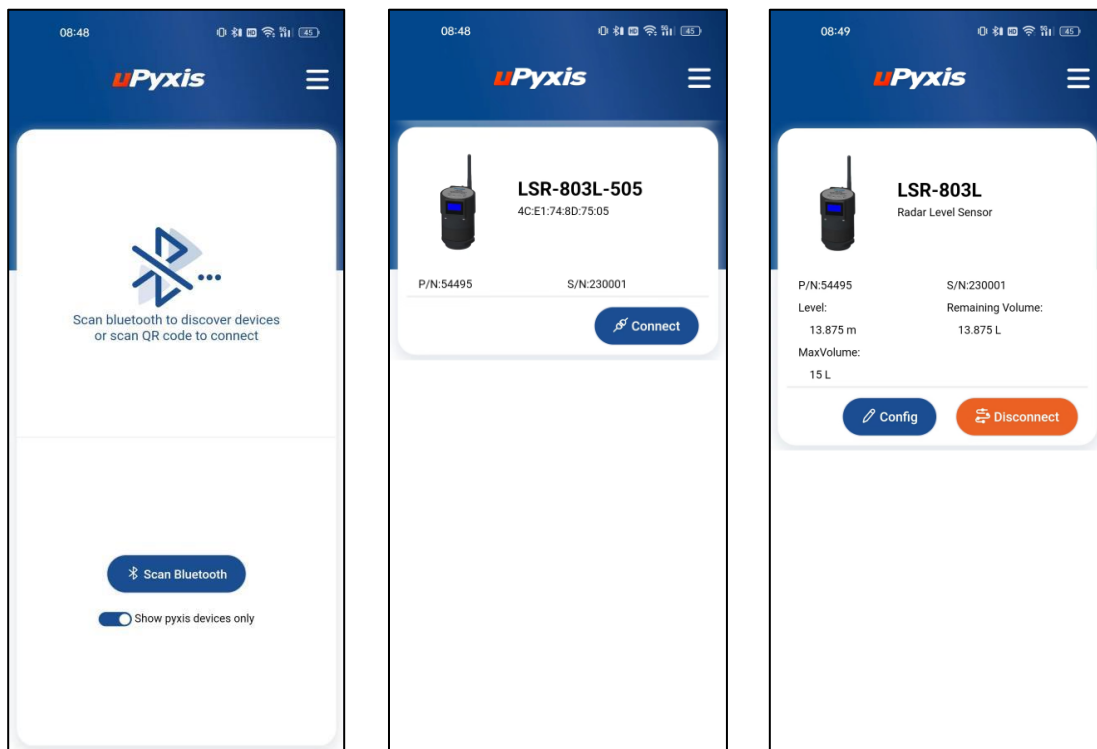

Figure 5. LSR-803 Series Radar Level Sensor Connection

6.3 Parameter Setting via uPyxis Mobile App

There are three-tab pages on the main screen as showed below. After connected, Mobile App will display the **Trend Chart** screen. User can click on **Overview** tab to check more measurement information. And Configuration Tab is for user to change the settings of the sensor if needed.

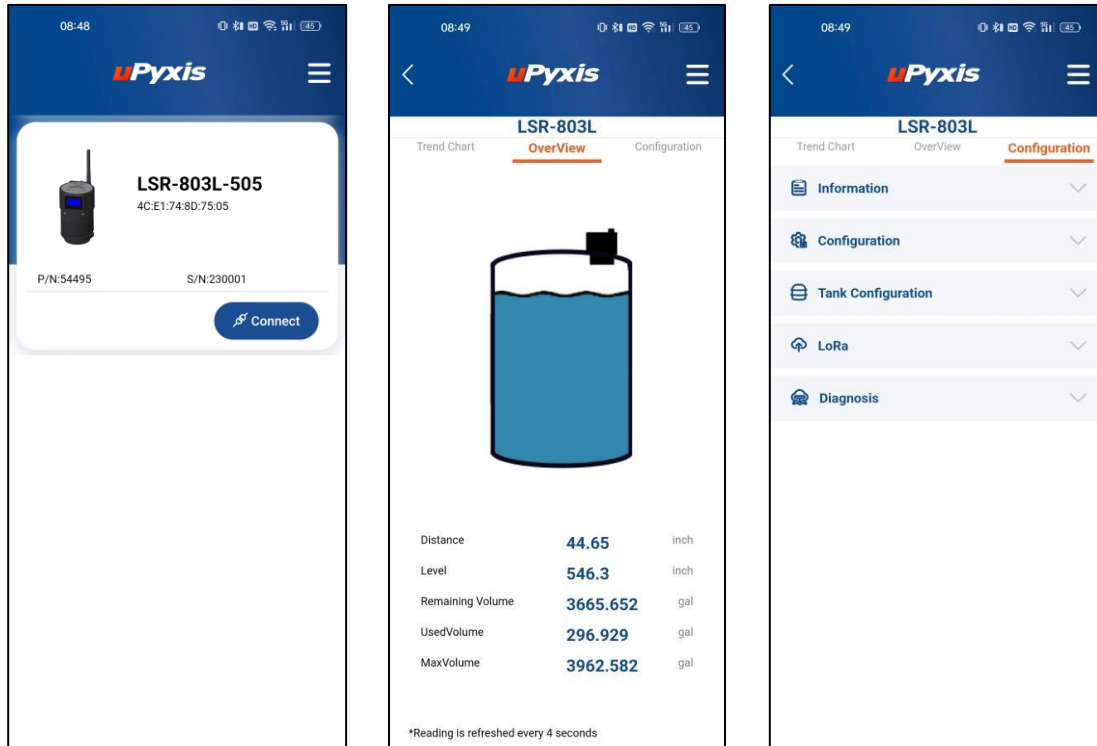

Figure 6. Sensor Tab Selection

In the **Configuration Tab** on the top of the page, the user can check the basic information of the sensor when clicking on **Information** sub menu.

If the user wants to rename the device name, change the communication parameters or display unit, please click on the **Configuration** sub menu.

To configure the tank, click on **Tank Configuration** sub menu and set **Tank Volume**, **Installation Height** and **Max Level Height** if needed. Please click on parameter data or the “PEN” image to the right of the related parameter to modify the parameter and then click on the “Apply” button to finish the setting.

To check the LoRa information or configure the LoRa, click on the **LoRa** sub menu and the three sub menus under LoRa: **Information**, **Configuration** and **Diagnosis** will be displayed. Please click on parameter data or the “PEN” image to the right of the related parameter to modify the parameter and then click on the “Apply” button to finish the setting.

NOTE Please make sure that the difference between the installation height and the maximum level height is greater than 1.97 inches, the sensor dead zone.

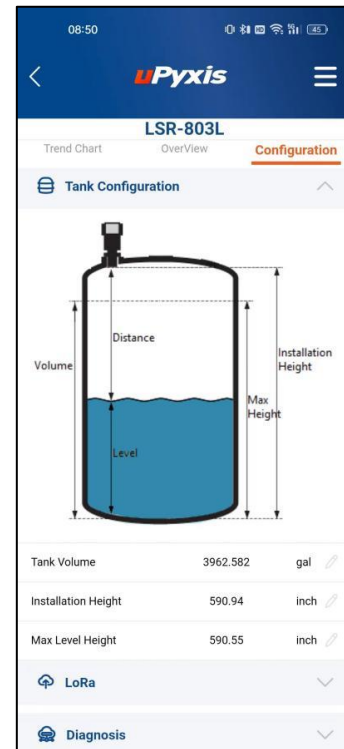
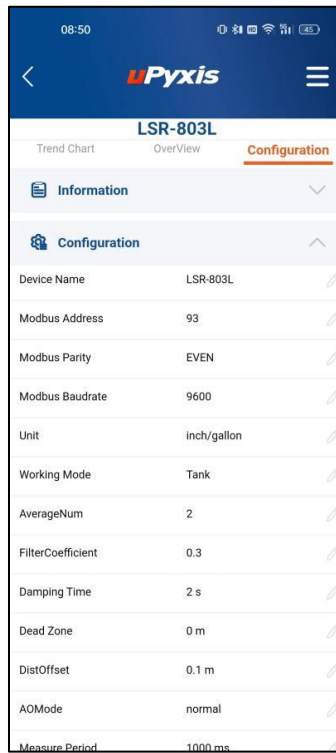
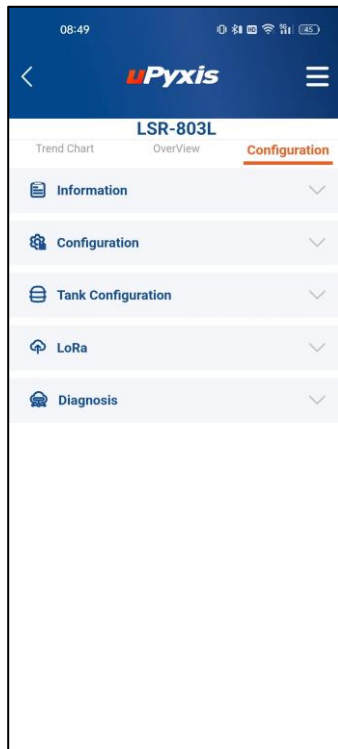

Figure 7. Sensor Configuration

6.4 Install the uPyxis Desktop App

Download the latest version of **uPyxis** Desktop software package from: <https://www.pyxis-lab.com/upyxis-app/> this setup package will download and install the Microsoft.Net Framework 4.5 (if not installed on the PC before), the USB driver for the USB-BlueTooth 5.0® adapter, and the main uPyxis Desktop application. Double click the **uPyxis.Setup.exe** file to bring up installation screen.

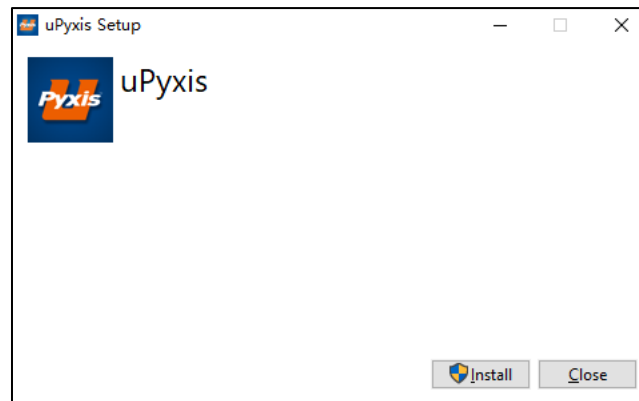



Figure 8. uPyxis desktop app installation

Click **Install** to start the uPyxis Desktop installation process. Follow the screen instructions to complete the USB driver and uPyxis installation.

6.5 Connecting to The uPyxis Desktop App

Connect the sensor to a Windows computer via Windows System Bluetooth (Win10 or above) according to the following steps:

1. Make sure the LSR-803 series is in Peripheral (P) Mode if you desire to configure the sensor. For tank level reading only, the unit may remain in Beacon (B) Mode.
2. Double click the uPyxis.exe icon  to launch the program on your Desktop.
3. On uPyxis Desktop, click menu Device -> **Connect via Windows System Bluetooth (Win10 or above)** as shown in Figure 9. If the connection is successful, the LSR-803 Series image and its Serial Number will be displayed in the left pane of the uPyxis window as shown in Figure 10.

NOTE For PC's using Windows prior to Win10, the user may require the Pyxis MA-NEB (USB to BlueTooth 5.0 Adapter) for Bluetooth connection to the LSR-803 series sensor. Plug the MA-NEB into the USB port of the PC and follow the same steps above, but when connecting choose -> **Connect via USB-RS485**. It may take up to 10 seconds for the adapter to establish the wireless communication with the LSR-803 series sensor in case MA-NEB BlueTooth 5.0®/USB adapter is used.



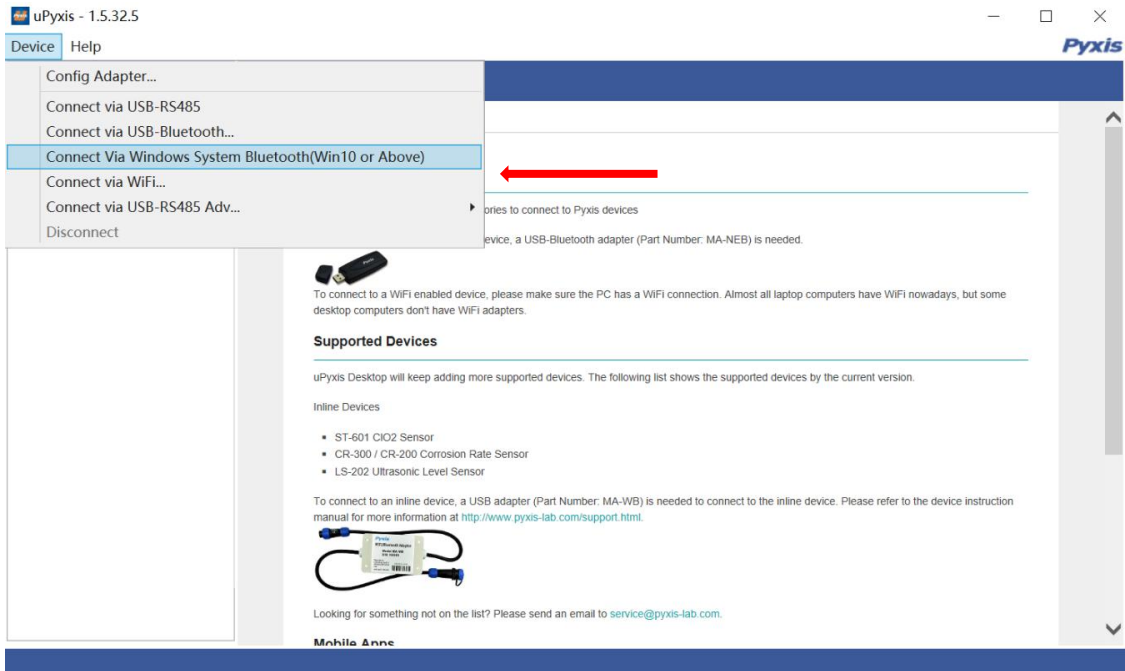

Figure 9. Connect uPyxis desktop app to LS-803 Series Radar Level Sensor

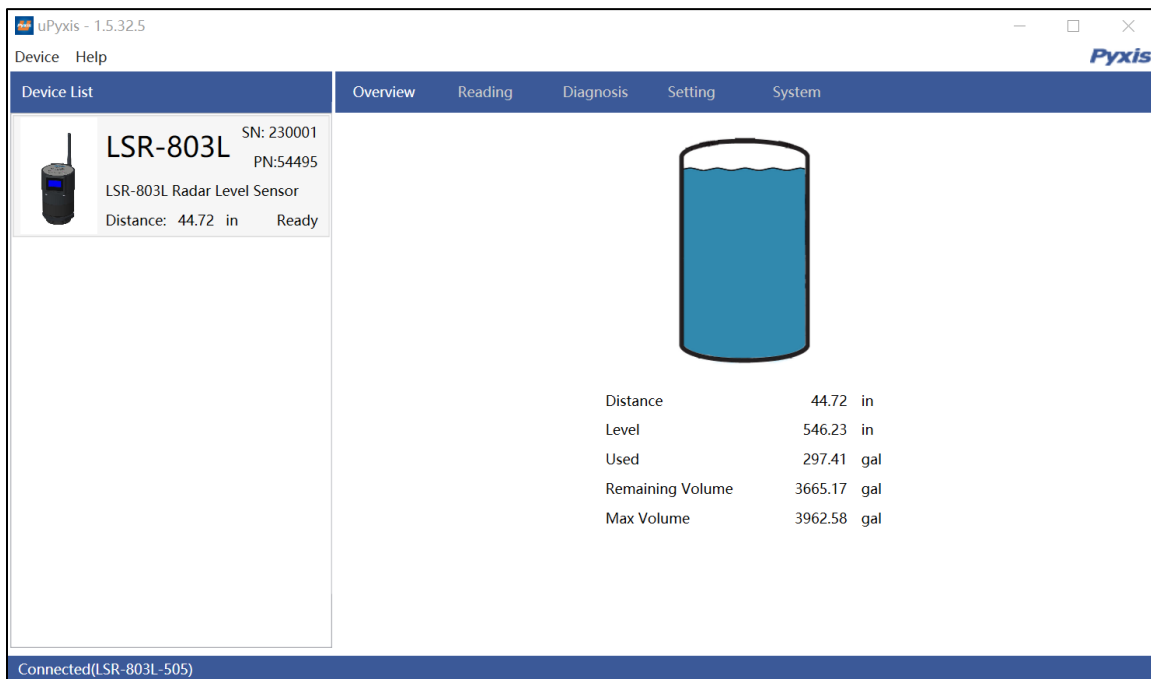

Figure 10. uPyxis Live Display After Connection to LSR-803L Series Sensor

6.6 Parameter Setting via uPyxis Desktop App

Click **Setting** to set the parameters as show in Figures 11 - 13. The sensor measures the distance between the liquid surface in the tank and the bottom sensor surface. Converting this measured distance to other parameters such as the tank level, the remaining liquid volume, or the consumed liquid, requires the tank dimensional and volume capacity information. Common vertical tanks have a uniform horizontal cross section. As such, the liquid volume is proportional to the liquid level. To convert the measured distance to volumetric information, requires the user to enter three parameters via the uPyxis Mobile or Desktop apps as shown in Figure 11.

The **Maximum Height** (Figure 11) is the liquid level measured from the tank bottom when the tank is filled to the rated **Volume** capacity. The **Installation Height** is the distance between tank bottom and the sensor bottom surface. ****NOTE*** Please make sure that the difference between the installation height and the maximum level height is greater than 1.97 inches, the sensor dead zone.*

For horizontal or other tanks that have a non-uniform cross section, please contact Pyxis Technical Support team (service@pyxis-lab.com) for assistance.

Definitions of Terms

See table below providing definition of terms as used in Figures 11 – 13. ****NOTE*** After entering any setup parameter, click the Apply Settings button to save the setting.*

Term	Definition
Volume	Volume of the tank
Max Height	Liquid level measured from the tank bottom as filled to rated capacity
Installation Height	The distance between the tank bottom and the sensor bottom surface.
Display Unit	Inch-Gallon / Meter-Liter / Centimeter-Liter

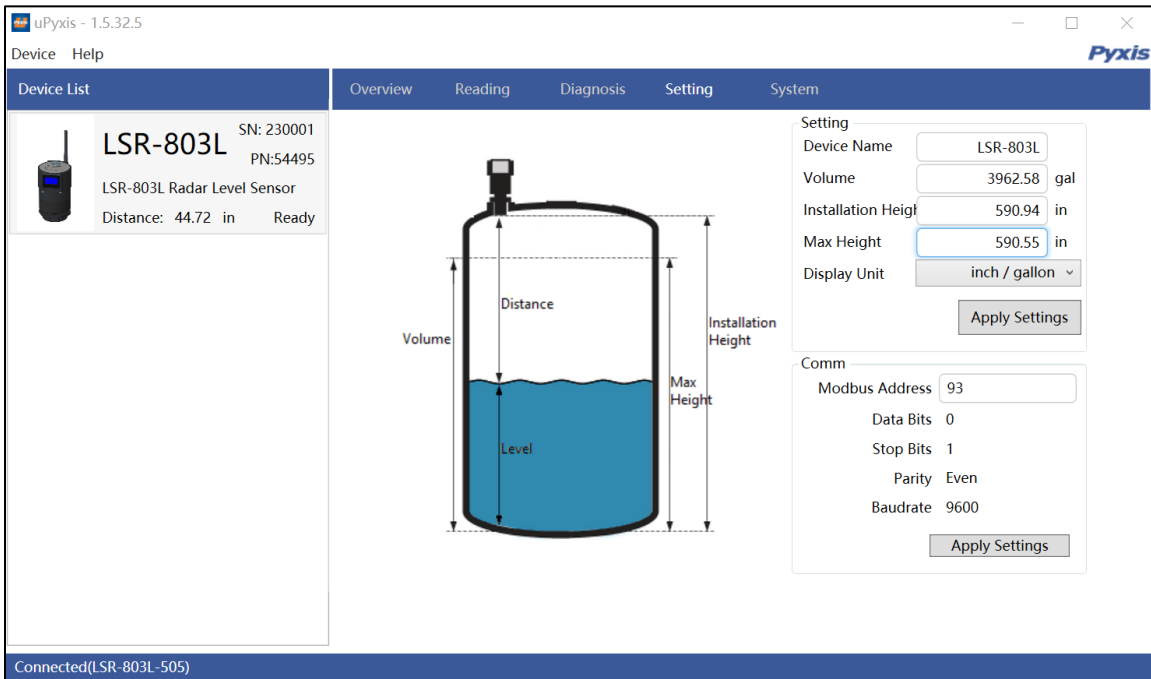

Figure 11. Illustration of terms and tank capacity setup

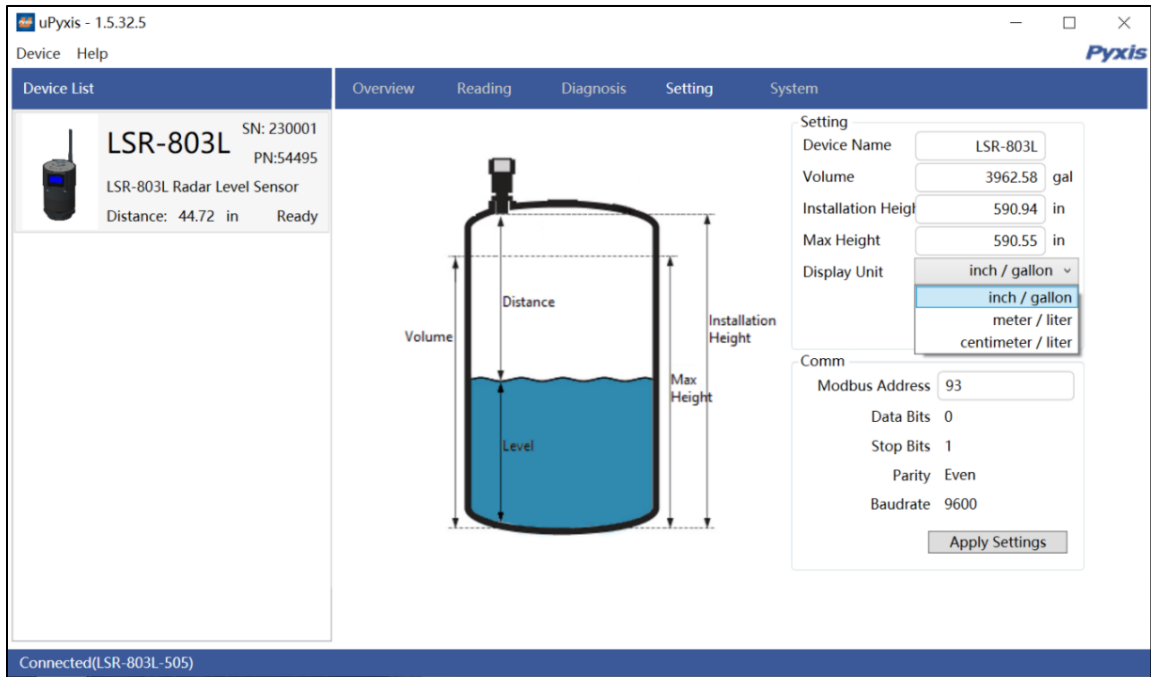

Figure 12. Display Unit Dropdown Selection

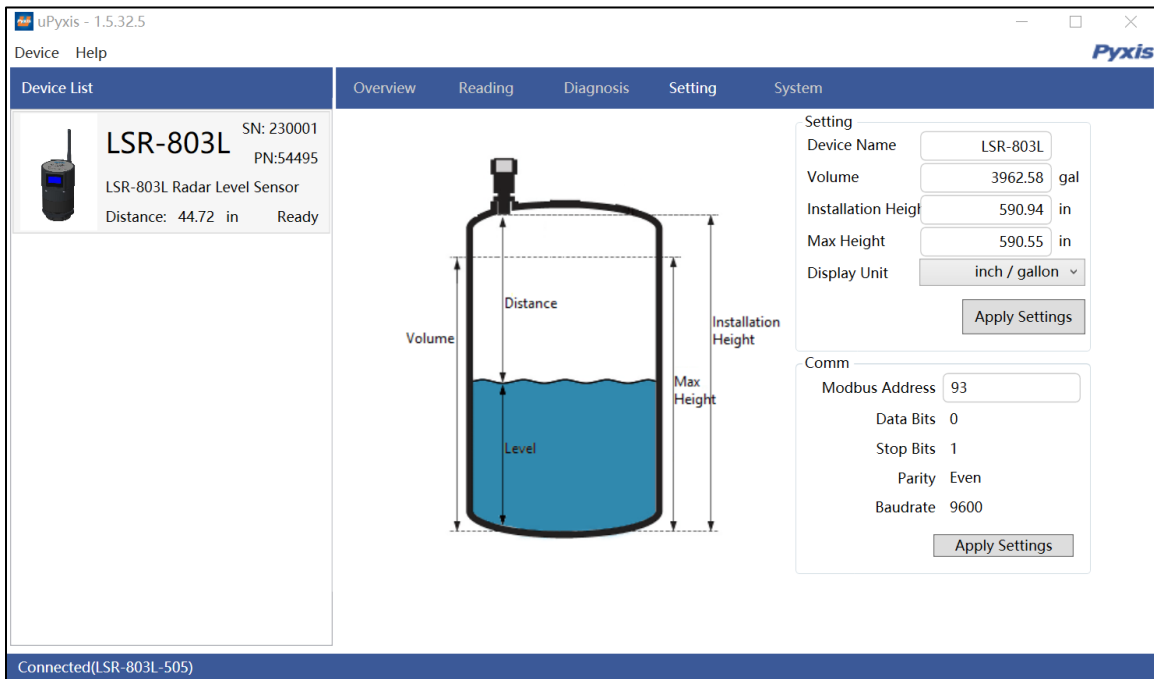

Figure 13. Click apply settings button to save the settings

Click **Reading** menu to display real-time measurement data in a trend chart (Figure 14).

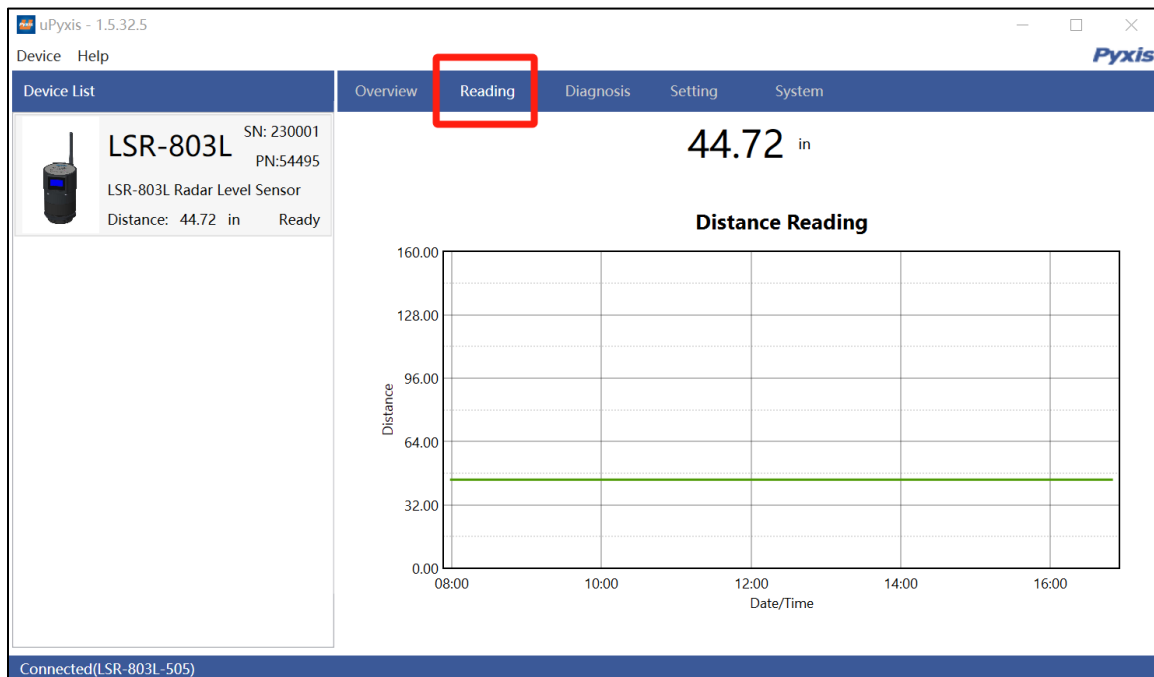

Figure 14. Level Trend Chart

Click **System** to upgrade firmware as shown in Figure 15. Contact service@pyxis-lab.com for the latest LSR-803 series firmware.

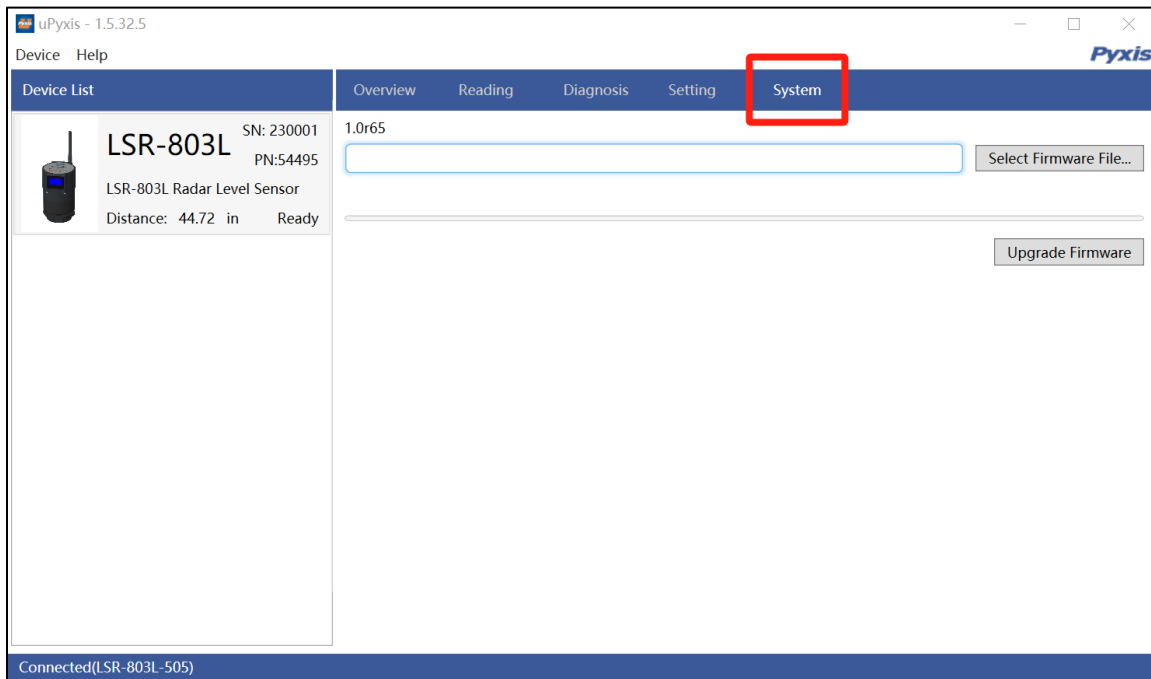

Figure 15. Firmware Upgrade

6.7 4-20 mA Output Setup

The 4-20 mA output of the LSR-803 series sensor will be scaled as outlined below following user configuration via uPyxis.

4 mA = (Tank is Empty) = (Level is 0) = (Distance is Installation Height),

20 mA = (Tank is Full) = (Level is maximum height) = (Distance is Installation Height – Maximum Height).

The 4-20 mA analog signal can be converted to one of four values (Level, Distance, Volume Remaining, or Volume Consumed) in the controller receiving the output according to the above scale.

Example: A nominal 100-gallon vertical tank, the maximum height is 36 inches and installation height is 42 inches. The tank volume is 100 gallons when it is filled up to the maximum height of 36 inches. The controller should be set up to convert 20 mA to 100 gallons, at which the tank is full and the tank level is 36 inches and the distance measured is 6 inches (Installation Height – Maximum Height).

NOTE The nominal capacity provided by the tank manufacturer may be greater than the maximum safe (net or effective) capacity that can be practically filled. Please keep this in mind as you configure your LSR-803 series sensor for practical purposes. Unlike other sensors on the market, the LSR-803 series level sensor does **NOT** require the storage tank to contain liquid to be properly configured. The user may configure the sensor on an empty tank or prior to installation if desired.

7. Communication Using Modbus RTU

The sensor can be configured as a Modbus slave device via RS-485. In addition to the level, volume, and distance, many operational parameters, including warning and error messages, are available via a Modbus RTU connection. Contact Pyxis Lab Customer Service (service@pyxis-lab.com) for more information.

8. Communication Using LoRa (For LSR-803L Only)



LoRa (short for Long Range) is a wireless radio communication technology that allows low-power devices to communicate with a LoRa capable Gateway over long distances. Pyxis Lab has added LoRa capability to the LSR-803L (P/N 54495) radar level sensor for future utilization with Pyxis LoRa embedded 4G Gateway technology. After the sensor with LoRa is powered-up, it will automatically register into the LoRa gateway within range allowing collection of operational parameters from the sensor, including level, volume, distance, settings etc. The LoRa gateway acts as a bridge between the sensor and the Internet or Controller, and it can communicate with many sensors at the same time. Pyxis Lab LoRa embedded 4G Gateway is currently in the final stages of development. Contact service@pyxis-lab.com to find out details of availability.

9. DELIVERY DISPLAY MODE - Explanation & Overview

9.1 Filling Liquid into The Storage Tank with Delivery Display Mode

Use of the Delivery Display Mode feature is recommended during the fill process of chemical, reagent, or liquid into the storage tank. In this mode, an enhanced large OLED display of liquid volume is provided to reflect the rapid liquid inventory change during the entire filling process. After 20-minutes, the LSR-803 series sensor will default back to its previous display mode setting. ***NOTE*** *The consumption of AA-battery power is elevated while the sensor is operated in this display mode.*

Follow the following steps:

- 1) Press and Hold the **Power** button  for 1 second to relight up OLED display (only power button has this function)
- 2) Double click the **Power** button  to switch the probe working mode to **Delivery Display Mode** and the OLED will display the current liquid volume in large font for 20-minutes as shown below.

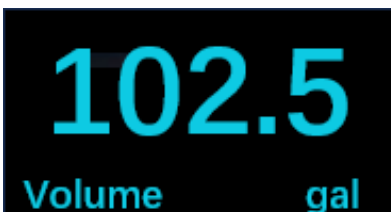

- 3) The values on the screen are refreshed during the filling process. When liquid level is higher than the max height minus 5cm, the screen will begin blinking to remind the user that the filling process is near completion. The blinking will stop after 1 minute automatically or if the liquid level is lower than the max height minus 10cm.
- 4) The filling process is completed when the Volume become FULL, then Quick double click  to revert the probe working mode back to the previous normal mode. Please notice that if the working time of delivery mode exceeds 20 minutes, the sensor will automatically quit delivery mode and revert back to the previously programmed mode.

9.2 Monitoring Tank Liquid Consumption

Refresh the screen value according to the setting interval. When the screen display is off, hold the power button  for 1 second to relight up OLED display (Only power button has this function).

10. Sensor Maintenance and Precaution

For best performance, keep the antenna lens clean using a soft cloth or towel. Please note that in some applications, buildup on the antenna lens can affect the measurement results. If necessary, clean the antenna lens in as needed intervals.

11. Regulatory Approval

United States

The LSR-803L sensor has been tested and found to comply with the limits for a Class B digital device, pursuant to part 15 of the FCC Rules. These limits are designed to provide reasonable protection against harmful interference in a residential installation. This equipment generates, uses and can radiate radio frequency energy, and if not installed and used in accordance with the instructions, may cause harmful interference to radio communications. However, there is no guarantee that interference will not occur in an installation. If this equipment does cause harmful interference to radio or television reception, which can be determined by turning the equipment off and on, the user is encouraged to try to correct the interference by one or more of the following measures:

- Reorient or relocate the receiving antenna.
- Increase the separation between the equipment and receiver.
- Connect the equipment into an outlet on a circuit different from that to which the receiver is connected.
- Consult the dealer or an experienced radio/TV technician for help

Canada

This device complies with Industry Canada license exempt RSS standard(s). Operation is subject to the following two conditions: (1) this device may not cause interference, and (2) this device must accept any interference, including interference that may cause undesired operation of the device.

Le présent appareil est conforme aux CNR d'Industrie Canada applicables aux appareils radio exempts de licence. L'exploitation est autorisée aux deux conditions suivantes: (1) l'appareil ne doit pas produire de brouillage, et (2) l'utilisateur de l'appareil doit accepter tout brouillage radioélectrique subi, même si le brouillage est susceptible

Contact Us

Pyxis Lab, Inc.

21242 Spell Circle Dr.

Tomball, TX 77375 USA

www.pyxis-lab.com / service@pyxis-lab.com