



LSR-801 Series Level Sensors

Radar Level Transmitters



Pyxis Lab® Inc.

1729 Majestic Dr. (Suite 5)

Lafayette, CO 80026

www.pyxis-lab.com

USER MANUAL



The information contained in this manual may be confidential and proprietary and is the property of Pyxis Lab, Inc. Information disclosed herein shall not be used to manufacture, construct, or otherwise reproduce the goods described. Information disclosed herein shall not be disclosed to others or made public in any manner without the express written consent of Pyxis Lab, Inc.

Limited Warranty

Pyxis Lab warrants its products for defects in materials and workmanship. Pyxis Lab will, at its option, repair or replace instrument components that prove to be defective with new or remanufactured components (i.e., equivalent to new). The warranty set forth is exclusive and no other warranty, whether written or oral, is expressed or implied.

Warranty Term

The Pyxis warranty term is thirteen (13) months ex-works. In no event shall the standard limited warranty coverage extend beyond thirteen (13) months from the original shipment date.

Warranty Service

Damaged or dysfunctional instruments may be returned to Pyxis for repair or replacement. In some instances, replacement instruments may be available for short duration loan or lease.

Pyxis warrants that any labor services provided shall conform to the reasonable standards of technical competency and performance effective at the time of delivery. All service interventions are to be reviewed and authorized as correct and complete at the completion of the service by a customer representative or designate. Pyxis warrants these services for 30 days after the authorization and will correct any qualifying deficiency in labor provided that the labor service deficiency is exactly related to the originating event. No other remedy, other than the provision of labor services, may be applicable.

Repair components (parts and materials), but not consumables, provided during a repair, or purchased individually, are warranted for 90 days ex-works for materials and workmanship. In no event will the incorporation of a warranted repair component into an instrument extend the whole instrument's warranty beyond its original term.

Warranty Shipping

A Repair Material Authorization Number (RMA) must be obtained from Pyxis Technical Support before any product can be returned to the factory. Pyxis will pay freight charges to ship replacement or repaired products back to the customer. The customer shall pay freight charges for returning products to Pyxis. To receive an RMA you can generate a request on our website at <https://www.pyxis-lab.com/request-return-or-repair/>

Pyxis Technical Support

You can contact Pyxis Technical Support at 1-866-203-8397 or service@pyxis-lab.com

Table of Contents

1.	Introduction.....	4
2.	Specifications.....	4
3.	Unpacking Instrument.....	5
3.1	Standard Provided Accessories.....	5
3.2	Optional Accessories.....	5
4.	Installation.....	6
4.1	Wiring.....	6
4.2	Tank Top Installation and Precautions.....	6
5.	Instrument Overview	11
5.1	LED Indicators	11
6.	Setup with uPyxis 2.0 Mobile & Desktop Apps	12
6.1	Download uPyxis 2.0 Mobile App	12
6.2	Connecting to uPyxis 2.0 Mobile App	12
6.3	Parameter Setting via uPyxis Mobile App.....	13
6.4	Install uPyxis Desktop App	14
6.5	Connecting to The uPyxis Desktop App	15
6.6	Parameter Setting via uPyxis Desktop App.....	16
6.7	4-20 mA Output Setup	20
7.	Communication Using Modbus RTU	21
8.	Communication Using LoRa (<i>For LSR-801L Only</i>).....	21
9.	Sensor Maintenance and Precaution	21
10.	Regulatory Approval.....	22
	Contact Us.....	22

1. Introduction

The Pyxis LSR-801 Series sensors are W-band FMCW continuous frequency modulation radar level transmitters. They provide continuous level measurement up to 591 inches (49.2 ft. or 15 m) with 4-20 mA output as well as RS485, BlueTooth 5.0[®]. The LSR-801L is also equipped with LoRa (Long Range Radio) digital output for long-distance wireless level sensor data access. The LSR-801 Series can be wirelessly configured via the Pyxis **uPyxis**[®] app for Mobile or Desktop devices enabling rapid integration and deployment in the field. The sensors are powered by a 24 VDC / 2.5W external power supply and are ideal for use with commonly used OEM controllers, PLC or DCS systems. This non-contact liquid level sensor platform is well suited for corrosive liquids and can be used for industrial, municipal and process liquid storage as well as chemical feed applications.

2. Specifications

Specification	LSR-801L	LSR-801
Part Number (P/N)	51959	54027
Power Supply	24 VDC, 2.5W Max	24 VDC, 2.0W Max
BlueTooth [®] Connectivity	BlueTooth 5.0 [®] 4.1, 32 ft. (10 Meters) Line of Sight for use with uPyxis	
Radio Output	Long Range Radio (LoRa)	None
Wired Output	1x 4-20mA / RS-485 MODBUS / LoRa	
Output Cable	Waterproof 7-Pin (10ft / 3m) Cable with Adapter & Flying Lead	
Extension Cable	Waterproof Extension Cables Sold Separately	
Range	2 – 591 inches (0.05 – 15 meters)	
Resolution	0.02 inch (0.5 mm)	
Accuracy	±2mm	
Dead Zone	2 inch (5 cm)	
Measurement Interval	Continuous (avg of 3 readings/second)	
Installation	2-inch NPT	
Weight	0.45 pound (210 g)	
Dimension	Height: 4.33 inch (110 mm); Diameter: 2.95 inch (75 mm)	
Enclosure Material	Polycarbonate (PC), Polybutylene Terephthalate (PBT)	
Ambient Temperature	5 - 122 °F (-15 - 50 °C)	
Storage Temperature	-4 - 140 °F (-20 - 60 °C)	
Pressure	-29 – 58 PSI (-0.2 – 0.4 MPa)	
Enclosure Rating	IP66	IP67
Regulation	CE / RoHS / UKCA	

**With Pyxis' continuous improvement policy, this specification is subject to change without notice.*

3. Unpacking Instrument

Remove the instrument and find the standard accessories from the shipping container as listed below. Inspect each item for any damage that may have occurred during shipping. Verify that all accessory items are included. If any item is missing or damaged, please contact Pyxis Lab Customer Service at service@pyxis-lab.com or by phone at 1-866-203-8397.

3.1 Standard Provided Accessories

The LSR-801 Series level sensors as delivered are provided with the items outlined below.

- **LS-801L** Radar Level Sensor with LoRa (P/N 51959)
 - One **MA-L10** Waterproof 7-Pin Cable with Adapter & Flying Leads (10ft /3m)
- **LS-801** Radar Level Sensor (P/N 54027)
 - One **MA-L10** Waterproof 7-Pin Cable with Adapter & Flying Leads (10ft /3m)
- User Manual Can Be Downloaded at [Support Documents - Pyxis Lab, Inc. \(pyxis-lab.com\)](https://www.pyxis-lab.com/support-documents)

3.2 Optional Accessories

The following optional accessories are available for use with LSR-801 Series level sensor platform and are sold separately.

Optional Accessory Name / Description	P/N
MA-L10 <i>(10-ft Flying Lead Cable with 7Pin Waterproof Adapter)</i>	MA-L10
MA-L50 <i>(50-ft Extension Cables with 7Pin Waterproof Adapters)</i>	MA-L50
MA-L100 <i>(100-ft Extension Cables with 7Pin Waterproof Adapters)</i>	MA-L100
MA-AC-7US <i>(110VAC-24VDC Power Supply Adapter – 7Pin Waterproof – USA Plug)</i>	26398
MA-AC-7EU <i>(230VAC-24VDC Power Supply Adapter – 7Pin Waterproof – EU/DIN Plug)</i>	28787
LSR-MB-A001 <i>(2-inch PVDF Well Insert Vapor Barrier for LSR Sensors use with Amine / Ammonia)</i>	21290
LSR-MB-W001 <i>(LSR Series – Wall Mounting Bracket Kit Wall Mounting Installs)</i>	24658
LSR-MB-H001 <i>(LSR -801 Series – Hanging Mounting Bracket Kit Suspended Installs)</i>	26307
LSR-MB-B001 <i>(LSR Series – Belt Mounting Bracket Kit for Totes & Tank Strap Installs)</i>	23220
LG-100 <i>(LoRa Receiver & 4-20mA/RS-485 Converter for use with Pyxis Sensors)</i>	28903

4 Installation

4.1 Wiring

The LSR-801 Series level sensors should be powered by a 24V DC power supply from any standard controller, PLC or DCS. The sensors offer both 1x 4-20mA and 1x RS-485 Modbus outputs. The 24V DC negative (black wire) and 4-20mA- wire are internally connected from the LSR-801 Series sensor therefore it is unnecessary to connect the green to the 4-20 mA negative terminal in the controller. If a separate DC power supply other than from a controller is used, make sure that the output from the power supply is rated for 22-26 VDC @ 100mA. Under standard installations the clear wire is not landed and remains unused.

NOTE Pyxis recommends powering off the controller when landing wires to the controller terminal board while the adapter to LSR-801 series sensor is connected. Follow the wiring table below to connect the sensor to a controller or receiving device.

Wire Color	Designation
Red	24 V +
Black	24 V Power ground
White	4-20 mA +
Green	4-20 mA -
Blue	RS-485 A
Yellow	RS-485 B
Clear	Shield, earth ground

4.2 Tank Top Installation and Precautions

The sensor should be installed in a 2-inch bulkhead fitting on the top of the tank. The dimensions of the LSR-801 and LSR-801L sensors are shown in Figure 2. If a flat horizontal surface is not available on the top of the tank, please use a self-aligning bulkhead fitting so that the sensor can be adjusted to be perpendicular to the liquid surface.

- Install and adjust the sensor to be perpendicular to liquid surface
- Installation location should not be too close to container wall to avoid interference.
- The sensor has a 1.97 inch (5 cm) dead zone (DZ). Raise the probe to avoid the DZ if desired
- Do not install in a location which will cause the microwave to be obstructed
-

Top of Tank Installation Suggestions

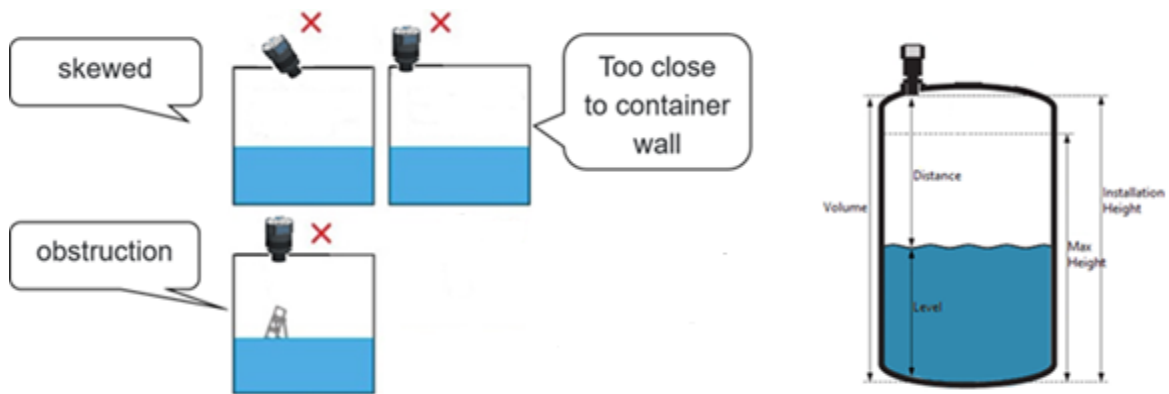

Figure 1. LSR-801 Series Installation Illustration

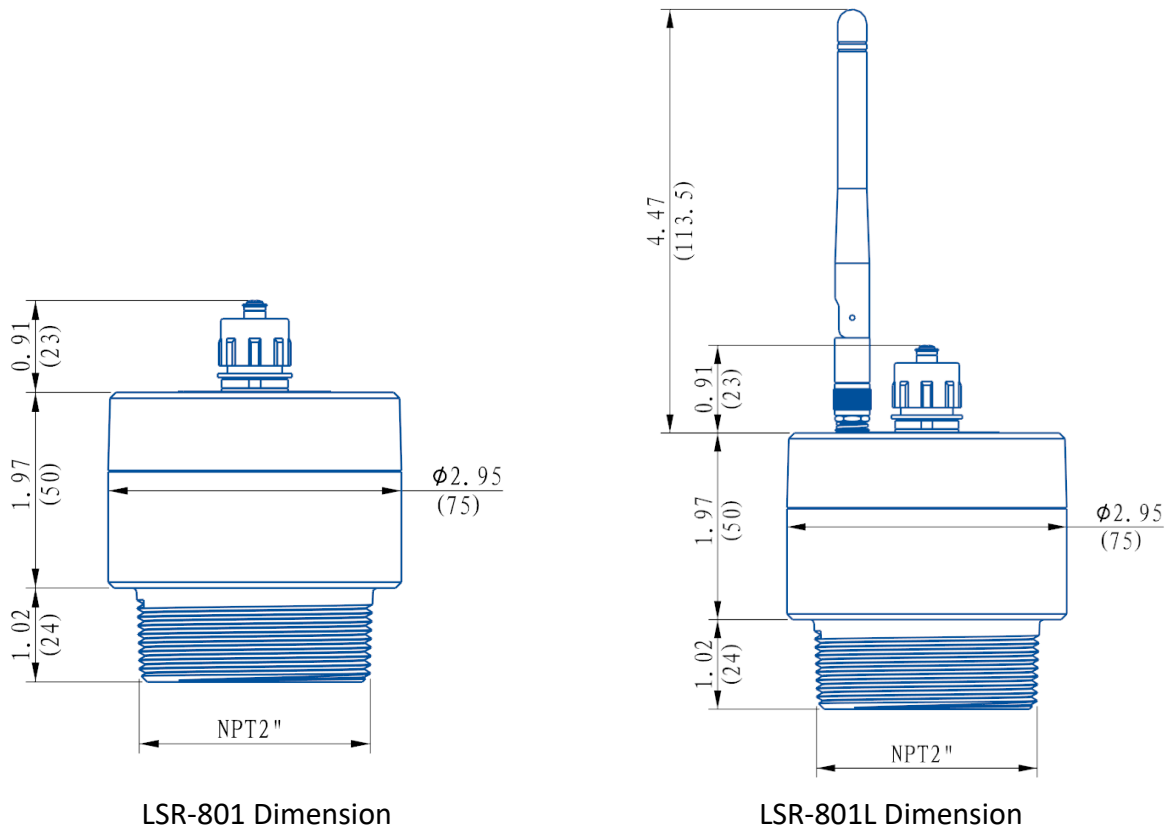
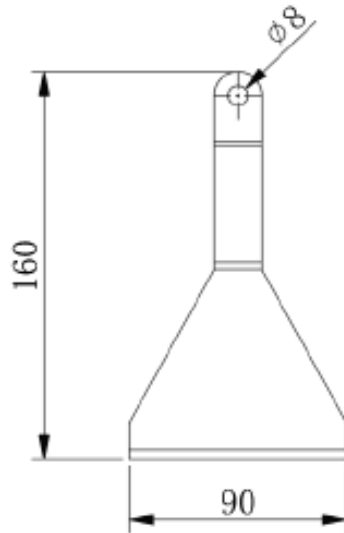
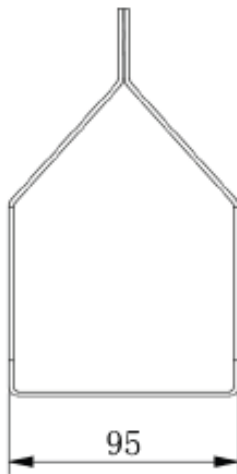

Figure 2. LSR-801 Series Dimensions, inch (mm)

HANGING Mount Kit

- **LSRMB-H001** (P/N 29307)
- Hanging (Suspended) Mounting for LSR-801 Series



BELT Mount Kit

- **LSRMB-B001** (P/N 23220)
- Belt Mounting for LSR-801 and LSR-803 Series on Drum or Tote

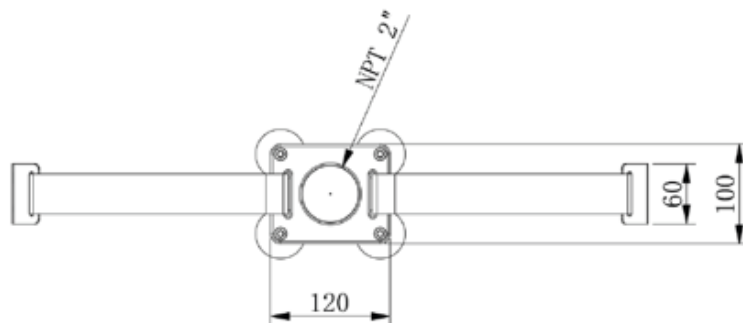
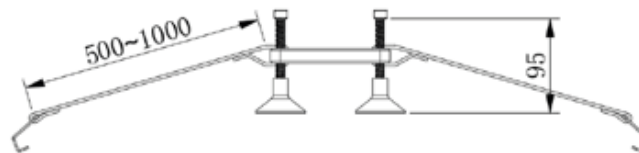
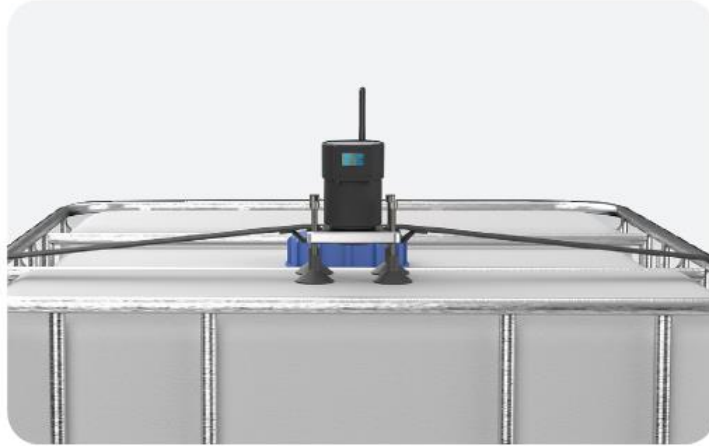

5 Instrument Overview

5.1 LED Indicators

The LED indicators on the top of the sensor (Figure 3) are used to indicate power status and BlueTooth 5.0® connection status.

LED Status	ON	OFF
Green LED	Power Supply is on	Power Supply is off
Blue LED	BlueTooth 5.0® is connected	BlueTooth 5.0® is disconnected

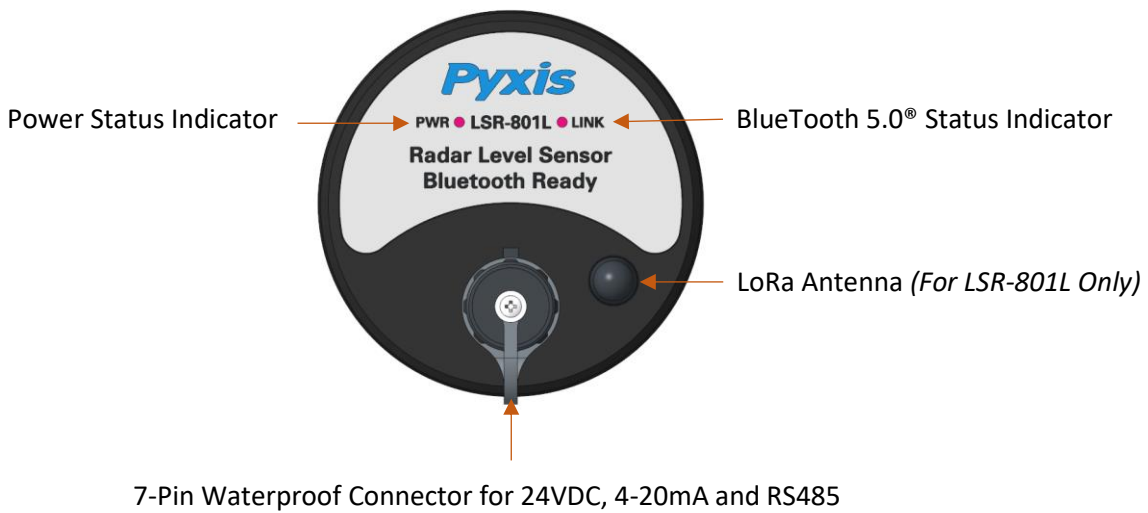

Figure 3. Sensor Connection and LED Indicators

6 Setup with uPyxis 2.0 Mobile & Desktop Apps

6.1 Download uPyxis 2.0 Mobile App

Download **uPyxis 2.0** Mobile APP from Apple [App Store](#) or [Google Play](#).



6.2 Connecting to uPyxis 2.0 Mobile App

Turn on the BlueTooth 5.0® on in your mobile device. ***NOTE*** Do not pair the phone's BlueTooth 5.0® to the LS-801 series sensor, the uPyxis 2.0 APP will do the pairing.

Open uPyxis 2.0 Mobile App. The App will start to search for Pyxis sensors automatically. Click on the [LS-801L Sensor Picture](#) to connect to the Pyxis Radar sensor.

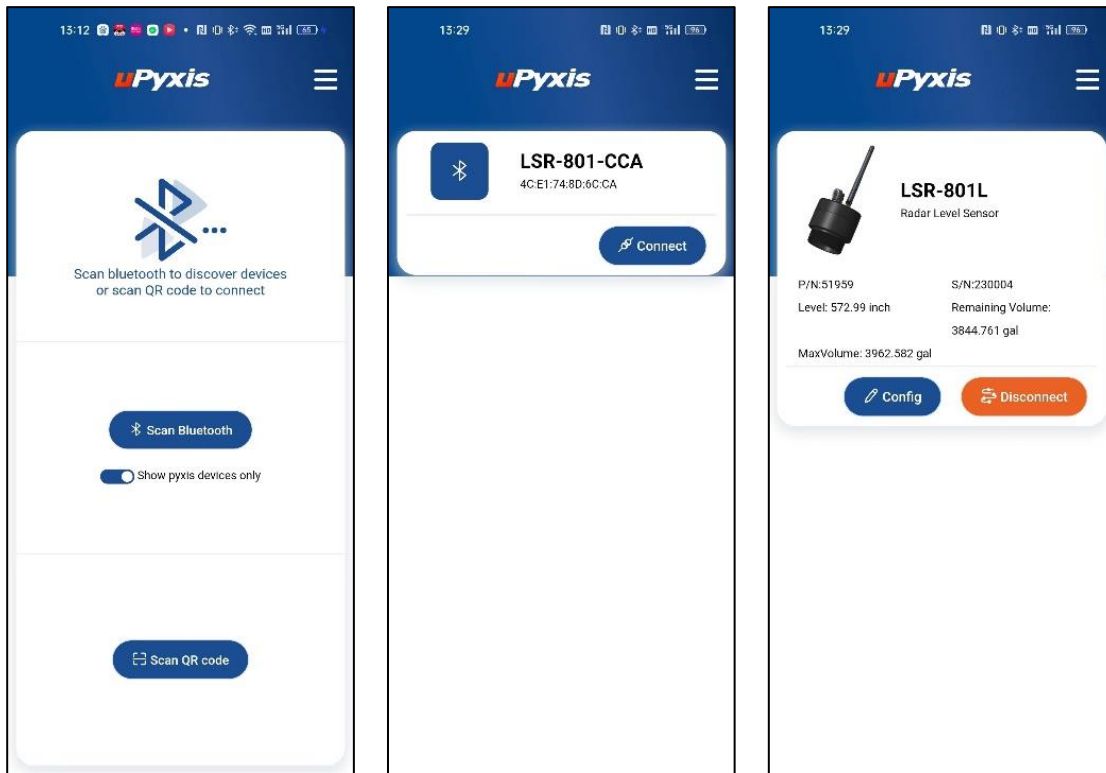

Figure 4. LSR-801 Series Radar Level Sensor Connection

6.3 Parameter Setting via uPyxis Mobile App

There are three-tab pages on the main screen as showed below. After connected, Mobile App will display the **Trend Chart** screen. User can click on **Overview** tab to check more measurement information. And Configuration Tab is for user to change the settings of the sensor if needed.

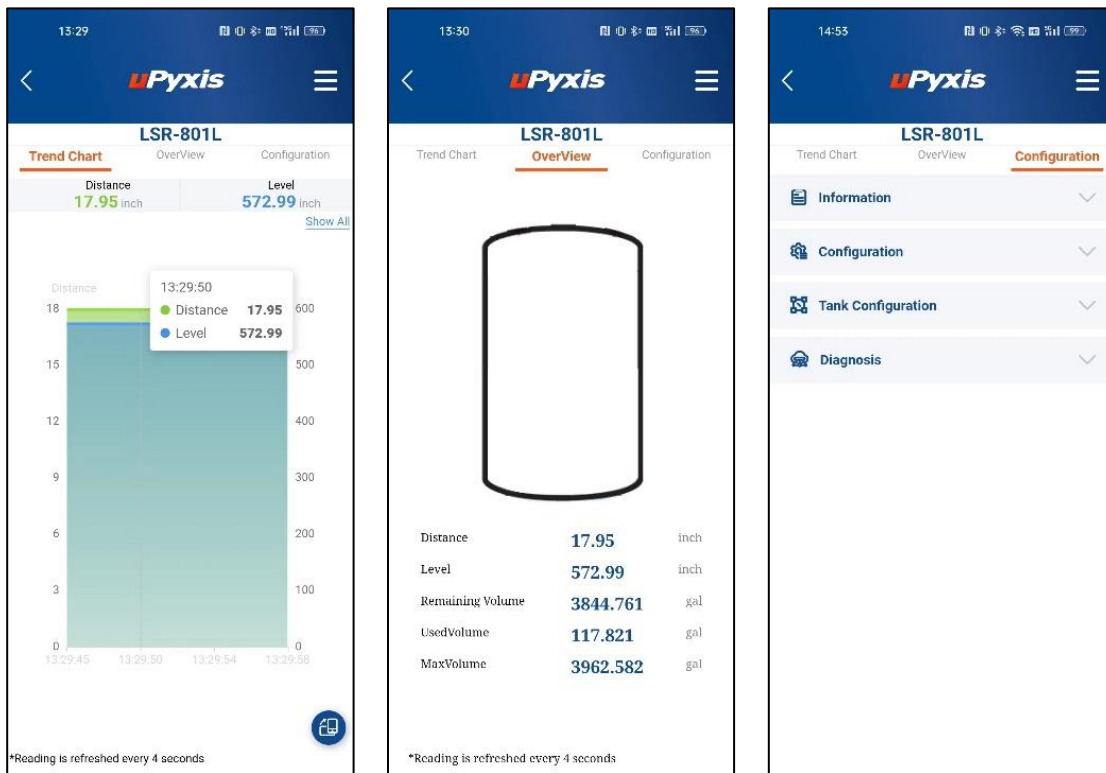

Figure 5. Sensor Tab Selection

In the **Configuration Tab** on the top of the page, the user can check the basic information of the sensor when clicking on **Information** sub menu.

If user wants to rename the device name, change the communication parameters or display unit, please click on the **Configuration** sub menu.

To configure the tank, click on **Tank Configuration** sub menu and set **Tank Volume**, **Installation Height** and **Max Level Height** if needed. Please click on the “PEN” image to the right of the related parameter to modify the parameter and then click on the “Apply” button to finish the setting.

NOTE Please make sure that the difference between the installation height and the maximum level height is greater than 1.97 inches, the sensor dead zone.

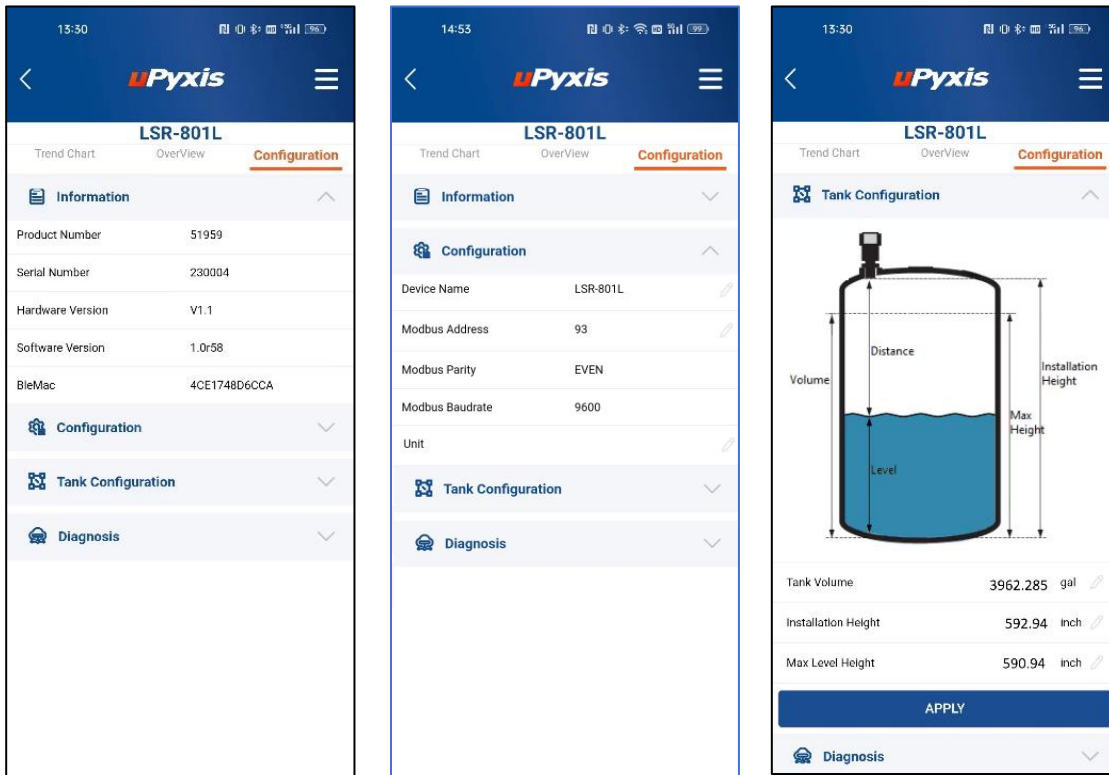

Figure 6. Sensor Configuration

6.4 Install uPyxis Desktop App

Download the latest version of **uPyxis** Desktop software package from: <https://www.pyxis-lab.com/upyxis-app/> this setup package will download and install the Microsoft.Net Framework 4.5 (if not installed on the PC before), the USB driver for the USB-BlueTooth 5.0® adapter, and the main uPyxis Desktop application. Double click the **uPyxis.Setup.exe** file to bring up installation screen.

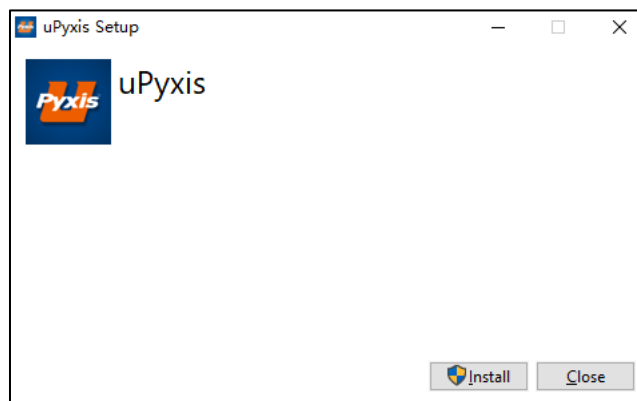



Figure 7. uPyxis desktop app installation

Click **Install** to start the uPyxis Desktop installation process. Follow the screen instructions to complete the USB driver and uPyxis installation.

6.5 Connecting to The uPyxis Desktop App

Connect the sensor to a Windows computer using a BlueTooth 5.0®/USB adapter (PN: MA-NEB, included in the package) according to the following steps:

1. Connect the BlueTooth 5.0®/USB adapter (PN: MA-NEB) to the computer USB.
2. Double click the uPyxis.exe icon  to launch the program on your Desktop.
3. On uPyxis Desktop, click menu Device -> **Connect via USB-BlueTooth 5.0®** as shown in Figure 8. If the connection is successful, the LSR-801 Series image and its Serial Number will be displayed in the left pane of the uPyxis window as shown in Figure 9.



NOTE After the LSR-801 Series and the MA-NEB BlueTooth 5.0®/USB adapter are powered up, it may take up to 10 seconds for the adapter to establish the wireless communication with the LSR-801 series sensor.



Figure 8. Connect uPyxis desktop app to LS-801 Series Radar Level Sensor

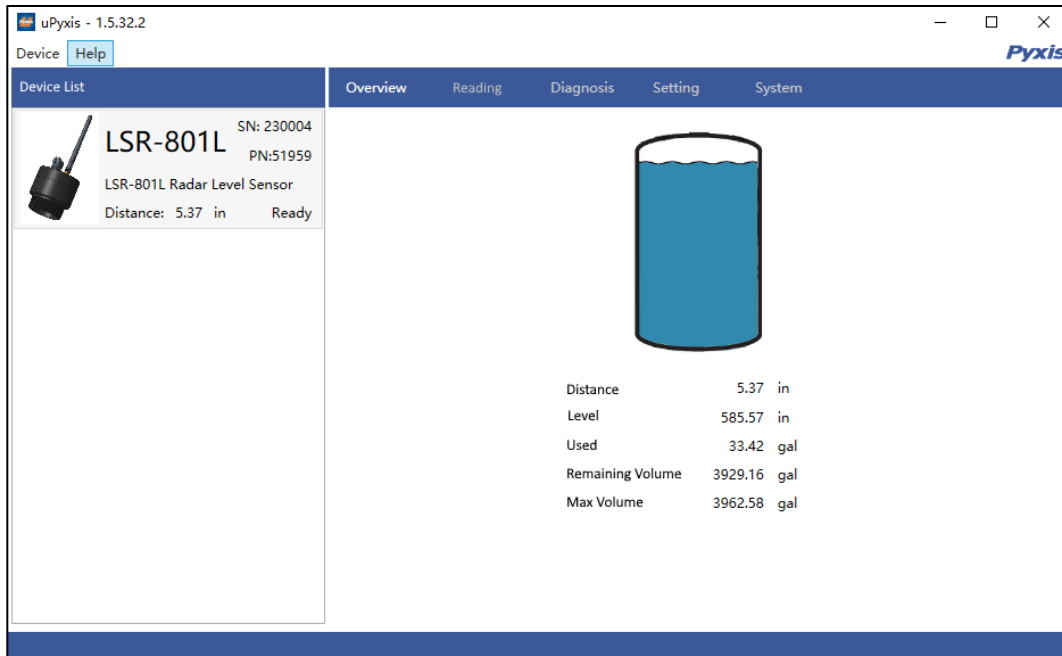

Figure 9. uPyxis Live Display After Connection to LSR-801 Series Sensor

6.6 Parameter Setting via uPyxis Desktop App

Click Setting to set the parameters as show in Figures 10 - 12. The sensor measures the distance between the liquid surface in the tank and the bottom sensor surface. Converting this measured distance to other parameters such as the tank level, the remaining liquid volume, or the consumed liquid, requires the tank dimensional and volume capacity information. Common vertical tanks have a uniform horizontal cross section. As such, the liquid volume is proportional to the liquid level. To convert the measured distance to volumetric information, it requires the user to enter three parameters via the uPyxis Mobile or Desktop apps as shown in Figure 10.

The **Maximum Height** (Figure 10) is the liquid level measured from the tank bottom when the tank is filled to the rated **Volume** capacity. The **Installation Height** is the distance between tank bottom and the sensor bottom surface. ***NOTE*** Please make sure that the difference between the installation height and the maximum level height is greater than 1.97 inches, the sensor dead zone.

For horizontal or other tanks that have a non-uniform cross section, please contact Pyxis Technical Support team (service@pyxis-lab.com) for assistance.

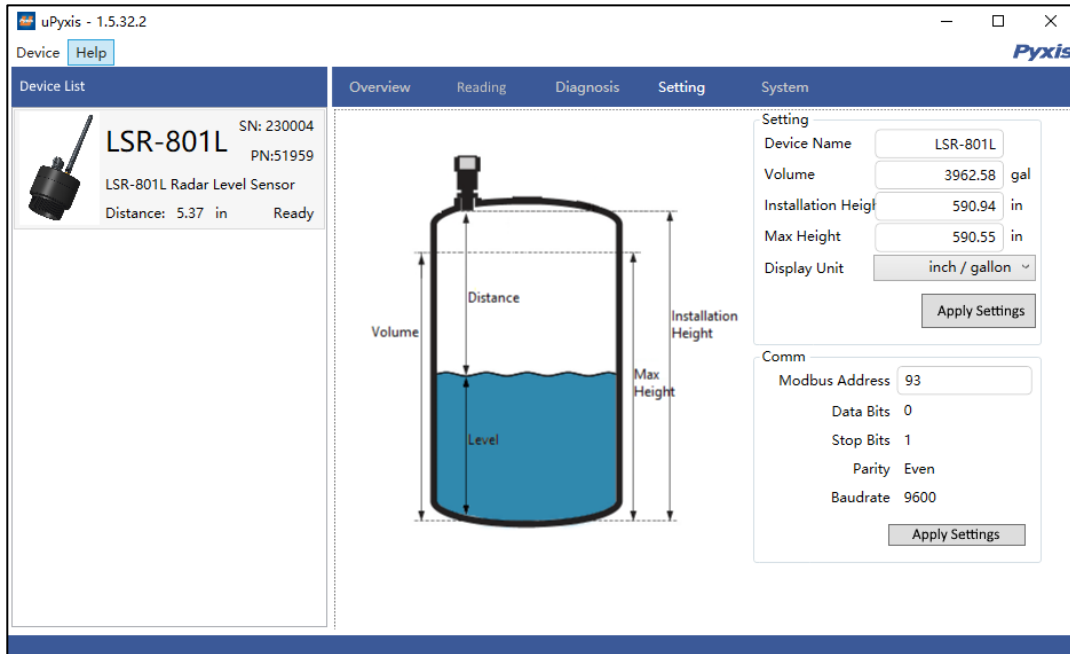

Figure 10. Illustration of terms and tank capacity setup

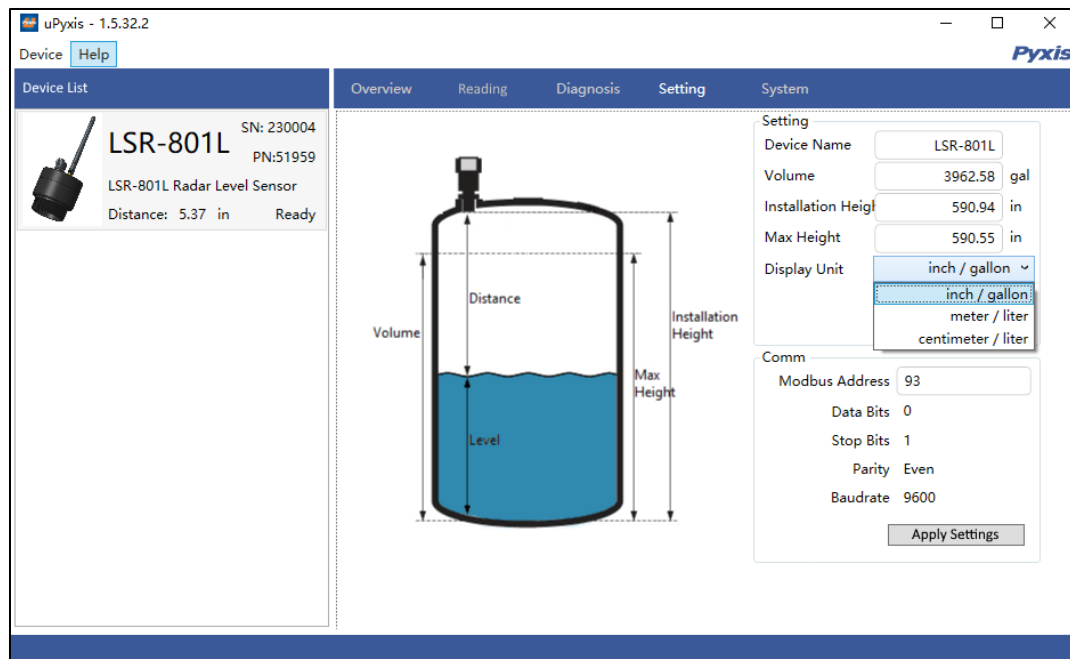

Figure 11. Display Unit Dropdown Seleccion

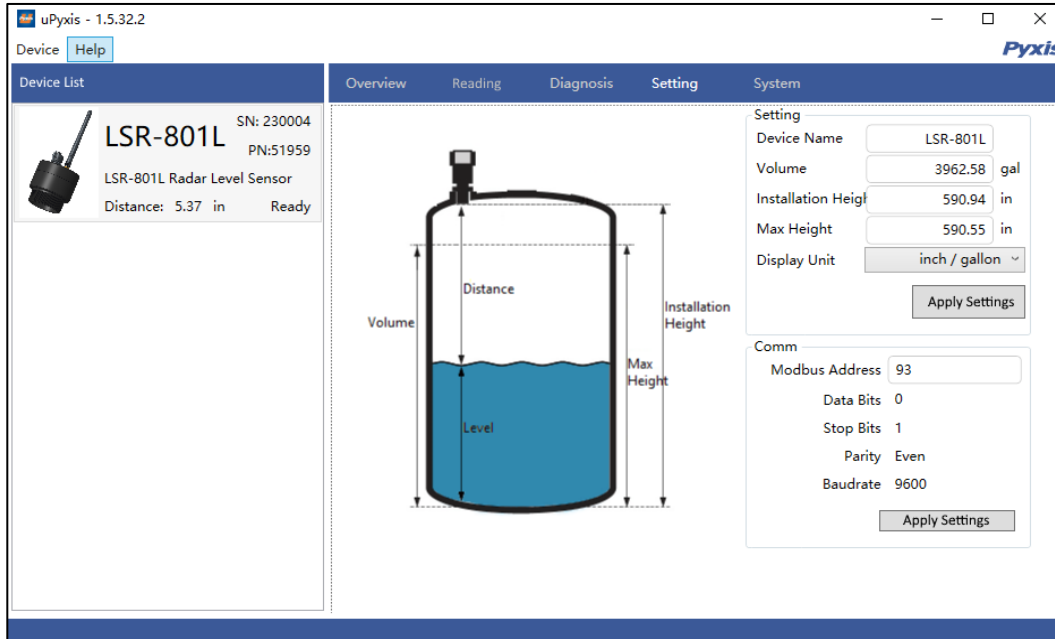

Figure 12. Click apply settings button to save the settings

Definitions of Terms

See table below providing definition of terms as used in figures 7 – 9. ***NOTE*** After entering any setup parameter, click the Set button to save the setting.

Term	Definition
Volume	Volume of the tank
Max Height	Liquid level measured from the tank bottom as filled to rated capacity
Installation Height	The distance between the tank bottom and the sensor bottom surface.
Display Unit	Inch-Gallon / Meter-Liter / Centimeter-Liter

Click **Reading** menu to display real-time measurement data in a trend chart (Figure 13).

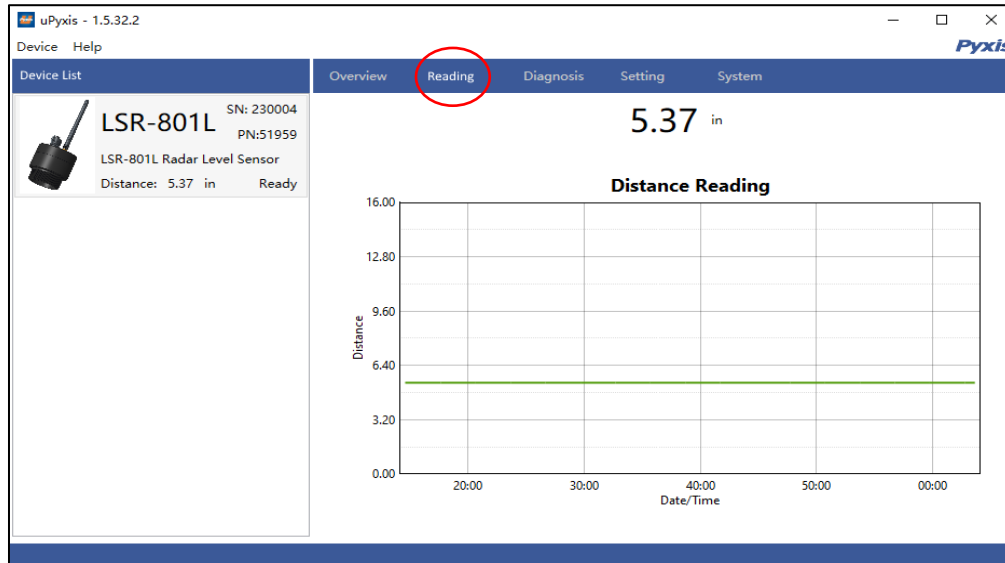

Figure 13. Level Trend Chart

Click **System** to upgrade firmware as shown in Figure 14. Contact service@pyxis-lab.com for the latest LSR-801 series firmware.

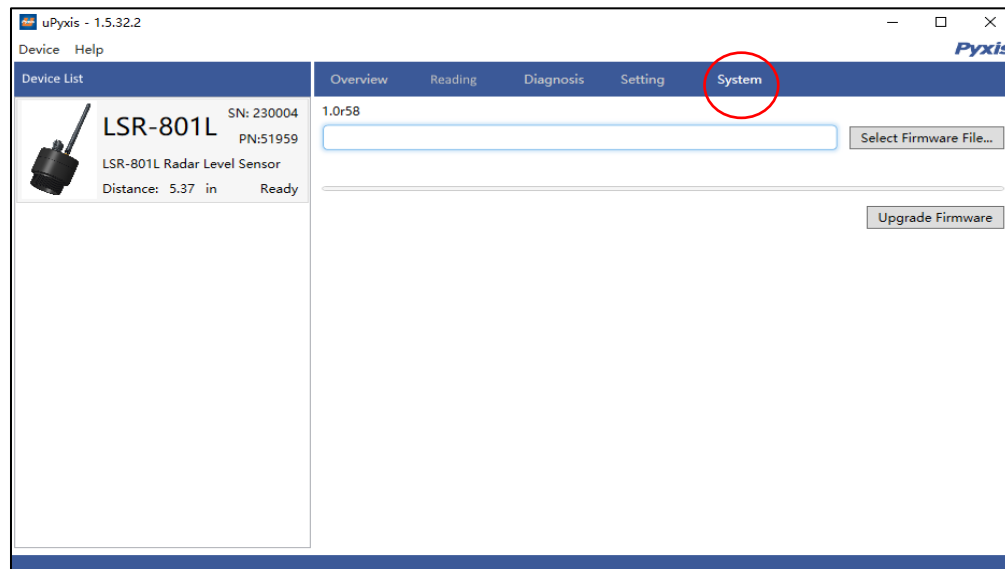

Figure 14. Firmware Upgrade

6.7 4-20 mA Output Setup

The 4-20 mA output of the LSR-801 series sensor will be scaled as outlined below following user configuration via uPyxis.

4 mA = (Tank is Empty) = (Level is 0) = (Distance is Installation Height),

20 mA = (Tank is Full) = (Level is maximum height) = (Distance is Installation Height – Maximum Height).

The 4-20 mA analog signal can be converted to one of four values (Level, Distance, Volume Remaining, or Volume Consumed) in the controller receiving the output according to the above scale.

For example, a nominal 100-gallon vertical tank, the maximum height is 36 inches and installation height is 42 inches. The tank volume is 100 gallons when it is filled up to the maximum height of 36 inches. The controller should be set up to convert 20 mA to 100 gallons, at which the tank is full and the tank level is 36 inches and the distance measured is 6 inches (installation height – maximum height).

NOTE *The nominal capacity provided by the tank manufacturer may be greater than the maximum safe (net or effective) capacity that can be practically filled. Please keep this in mind as you configure your LSR-801 series sensor for practical purposes. Unlike other sensors on the market, the LSR-801 series level sensor does NOT require the storage tank to contain liquid to be properly configured. The user may configure the sensor on an empty tank or prior to installation if desired.*

7. Communication Using Modbus RTU

The sensor can be configured as a Modbus slave device via RS-485. In addition to the level, volume, and distance, many operational parameters, including warning and error messages, are available via a Modbus RTU connection. Contact Pyxis Lab Customer Service (service@pyxis-lab.com) for more information.

8. Communication Using LoRa (*For LSR-801L Only*)

LoRa (short for Long Range) is a wireless radio communication technology that allows low-power devices to communicate with a LoRa capable Gateway over long distances. Pyxis Lab has added LoRa capability to the LSR-801L radar level sensor for future utilization with Pyxis LoRa embedded 4G Gateway technology. After the sensor with LoRa is powered-up, it will automatically register into the LoRa gateway within range allowing collection of operational parameters from the sensor, including level, volume, distance, settings etc. The LoRa gateway acts as a bridge between the sensor and the Internet or Controller, and it can communicate with many sensors at the same time. Pyxis Lab LoRa embedded 4G Gateway is currently in the final stages of development. Contact service@pyxis-lab.com to find out details of availability.

9. Sensor Maintenance and Precaution

For best performance, keep the antenna lens clean using a soft cloth or towel. Please note that in some applications, buildup on the antenna lens can affect the measurement results. If necessary, clean the antenna lens in as needed intervals.

10. Regulatory Approval

United States

The LSR-801L sensor has been tested and found to comply with the limits for a Class B digital device, pursuant to part 15 of the FCC Rules. These limits are designed to provide reasonable protection against harmful interference in a residential installation. This equipment generates, uses and can radiate radio frequency energy, and if not installed and used in accordance with the instructions, may cause harmful interference to radio communications. However, there is no guarantee that interference will not occur in an installation. If this equipment does cause harmful interference to radio or television reception, which can be determined by turning the equipment off and on, the user is encouraged to try to correct the interference by one or more of the following measures:

- Reorient or relocate the receiving antenna.
- Increase the separation between the equipment and receiver.
- Connect the equipment into an outlet on a circuit different from that to which the receiver is connected.
- Consult the dealer or an experienced radio/TV technician for help

Canada

This device complies with Industry Canada license exempt RSS standard(s). Operation is subject to the following two conditions: (1) this device may not cause interference, and (2) this device must accept any interference, including interference that may cause undesired operation of the device.

Le présent appareil est conforme aux CNR d'Industrie Canada applicables aux appareils radio exempts de licence. L'exploitation est autorisée aux deux conditions suivantes: (1) l'appareil ne doit pas produire de brouillage, et (2) l'utilisateur de l'appareil doit accepter tout brouillage radioélectrique subi, même si le brouillage est susceptible

Contact Us

Pyxis Lab, Inc.

1729 Majestic Dr. Suite 5

Lafayette, CO 80026 USA

www.pyxis-lab.com / service@pyxis-lab.com