

Pyxis[®]

SP-350RO Handheld PTSA Meter

User Manual



Water Professionals Deserve Better Tools.

www.pyxis-lab.com

SP-350RO Handheld PTSA Meter User Manual

March 15, 2023

Rev. 1.0

Pyxis Lab, Inc.

1729 Majestic Dr. Suite 5

Lafayette, CO 80026 USA

www.pyxis-lab.com

© 2017 Pyxis Lab, Inc.

Pyxis Lab Proprietary and Confidential

Table of Contents

1	Introduction	5
1.1	Main Features	5
2	Specifications	5
3	Unpacking Instrument	5
3.1	Standard Accessories	5
3.2	Optional Accessories	6
4	Installation	7
4.1	Battery Installation	7
5	Instrument Overview	8
5.1	Control Keys	8
5.2	Main Module On/Off.....	8
6	Measurement	8
6.1	PTSA Measurement.....	8
6.2	High Color and Turbidity Warning.....	9
7	Calibration	9
7.1	PTSA Calibration (Two-Point with Zero)	9
8	Device Information and Diagnosis	10
8.1	Sample Cell Cleanliness Check.....	11
8.2	Bluetooth Connection to Devices.....	12
8.2.1	Calibrate an ST-500 Series Sensor with the SP-350RO via Bluetooth	13
8.3	Factory Reset	15
9	Use with uPyxis® Mobile App	16
9.1	Download uPyxis® Mobile App.....	16
9.2	Connecting to uPyxis® Mobile App	17
9.3	Setting Screen	18
9.4	System Screen.....	19
10	Use with uPyxis® Desktop App	20
10.1	Install uPyxis® Desktop App.....	20
10.2	Connecting to uPyxis® Desktop App.....	21
10.3	System Screen.....	22
10.4	Datalog Screen.....	23
10.5	Setting Screen	23
11	Device Maintenance and Precaution	24
11.1	Maintenance Best Practices and Quick Tips	24
11.2	Methods to Cleaning the SP-350RO.....	24
11.3	Storage	25
12	Contact Us	25

Warranty Information

Confidentiality

The information contained in this manual may be confidential and proprietary and is the property of Pyxis Lab, Inc. Information disclosed herein shall not be used to manufacture, construct, or otherwise reproduce the goods described. Information disclosed herein shall not be disclosed to others or made public in any manner without the express written consent of Pyxis Lab, Inc.

Standard Limited Warranty

Pyxis Lab warrants its products for defects in materials and workmanship. Pyxis Lab will, at its option, repair or replace instrument components that prove to be defective with new or remanufactured components (i.e., equivalent to new). The warranty set forth is exclusive and no other warranty, whether written or oral, is expressed or implied.

Warranty Term

The Pyxis warranty term is thirteen (13) months ex-works. In no event shall the standard limited warranty coverage extend beyond thirteen (13) months from original shipment date.

Warranty Service

Damaged or dysfunctional instruments may be returned to Pyxis for repair or replacement. In some instances, replacement instruments may be available for short duration loan or lease.

Pyxis warrants that any labor services provided shall conform to the reasonable standards of technical competency and performance effective at the time of delivery. All service interventions are to be reviewed and authorized as correct and complete at the completion of the service by a customer representative, or designate. Pyxis warrants these services for 30 days after the authorization and will correct any qualifying deficiency in labor provided that the labor service deficiency is exactly related to the originating event. No other remedy, other than the provision of labor services, may be applicable.

Repair components (parts and materials), but not consumables, provided during a repair, or purchased individually, are warranted for 90 days ex-works for materials and workmanship. In no event will the incorporation of a warranted repair component into an instrument extend the whole instrument's warranty beyond its original term.

Warranty Shipping

A Repair Material Authorization (RMA) Number must be obtained from Pyxis Technical Support before any product can be returned to the factory. Pyxis will pay freight charges to ship replacement or repaired products to the customer. The customer shall pay freight charges for returning products to Pyxis. Any product returned to the factory without an RA number will be returned to the customer. To receive an RMA you can generate a request on our website at [Request Return or Repair - Pyxis Lab, Inc. \(pyxis-lab.com\)](http://pyxis-lab.com)

Pyxis Technical Support

Contact Pyxis Technical Support at +1 (866) 203-8397 or service@pyxis-lab.com.

1 Introduction

The Pyxis SP-350RO is a uniquely designed handheld multimeter that measures PTSA. It is a cuvette-less device. Less than 5 mL water sample is needed to fill the sample cell for proper measurement.

1.1 Main Features

The SP-350RO includes the following features:

- Measurement of the concentration of fluorescent tracer PTSA of a water sample.
- Pre-calibrated for measuring PTSA in the range of 0 to 40 ppb.
- The fluorescence PTSA measurement is automatically compensated for sample color and turbidity interference up to 60 NTU without prefiltration.
- PTSA fluorescence can be calibrated using a single standard through a user-friendly, menu-driven procedure.
- Large color graphic screen that can be read in direct sunlight.

2 Specifications

Table 1. SP-350RO Specifications

Item	Specification*
P/N	61389
PTSA Range	0–40 ppb
PTSA Precision	±1% or ±1 ppb
Temperature Range	40– 106 °F (4–41 °C)
Display	320×240 TFT-LCD, visible under direct sunlight
Power Supply	4 AA alkaline batteries
Typical Battery Life	10,000 readings
Dimension (L × W × H)	6.30 × 2.91 × 1.30 inch (160 × 74 × 33 mm)
Weight	0.68 lbs (310 g)
Enclosure Rating	IP67

* With Pyxis's continuous improvement policy, these specifications are subject to change without notice.

* Batteries excluded

3 Unpacking Instrument

Remove the instrument and accessories from the shipping container and inspect each item for any damage that may have occurred during shipment. Verify that all items listed on the packing slip are included. If any items are missing or damaged, please contact Pyxis Customer Service at service@pyxislab.com.

3.1 Standard Accessories

- Four (4) AA alkaline batteries
- Bluetooth/USB Adapter for Desktop P/N: MA-NEB
- User Manual available online at <https://pyxis-lab.com/support/>

3.2 Optional Accessories

The following optional accessories can be ordered from Pyxis Customer Service (order@pyxis-lab.com) or Pyxis E-Store at <https://pyxis-lab.com/shop/>.

Table 2.

Accessory Name	P/N
Pyxis Carrying Case for Handhelds MA-700	50725
Pyxis 30 ppb PTSA Calibration Standard — 500 mL	PTSA-30
Pyxis Handheld Cleaning Kit	SER-02

4 Installation

4.1 Battery Installation

The SP-350RO is powered by four alkaline batteries. Typical battery life lasts for 10,000 measurements or 10 months. When the battery capacity is critically low, the SP-350RO will display a " LOW BATTERY" warning for 5 seconds and then automatically turn off.

NOTE Do not use rechargeable nickel cadmium (NiCad) or lithium batteries.

Replace the batteries to resume operation of the SP-350RO after the battery warning. The SP-350RO will automatically turn on in the measurement mode after new batteries are installation.

The SP-350RO battery compartment, shown in Figure 1, is on the back side of the instrument. Batteries are held in place by a cover secured with two Phillips-head screws.

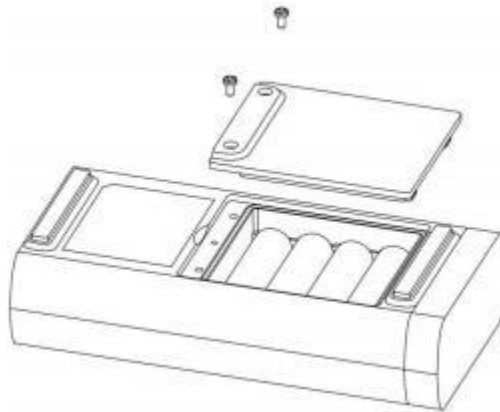

Figure 1. The SP-350RO battery compartment

Install batteries using the following steps:

1. Remove the battery compartment cover by loosening the two screws.
2. Remove old batteries and dispose of them properly.
3. Following the positive and negative terminal signs in the compartment bottom, snap four new AA alkaline batteries firmly into the battery holder.
4. Replace the battery compartment cover and ensure that the sealing O-ring is lying flat on the battery holder.
5. Fasten the two screws.

NOTE Failure to properly seat the O-ring may result in water damage to the SP-350RO.

5 Instrument Overview

5.1 Control Keys

The SP-350RO has three control keys, as shown in Figure 2. The left (<), right (>), and ok (OK) keys are used to launch actions indicated on the LCD display directly above the keys. The labels above the keys indicate the function associated with each key and functions can be changed in different operation modes.



Figure 2.

5.2 Main Module On/Off

To turn on the SP-350RO: Press **OK** momentarily and release.

To turn off the SP-350RO: Press and hold **OK** for about three seconds. Release **OK** when the LCD display turns off. The SP-350RO turns itself off after 60 seconds without user interaction detected. This is done to conserve battery life.

NOTE *This auto-time off setting may be customized by the user as desired through the uPyxis@ Mobile or Desktop App.*

6 Measurement

6.1 PTSA Measurement

When powered on, the SP-350RO will default to the PTSA measurement mode. The water sample can be transferred to the sample cell using a pipette or filled directly from a faucet, sample bottle, or sample valve.

NOTE *Special care should be taken when pouring the sample into the cell to avoid air bubble entrainment, which can interfere with reading accuracy.*

Before beginning a measurement, use the sample water to rinse the sample cell at least three times . Allow 5– 10 seconds for the SP-350RO to stabilize. The values will be displayed in **white with a blue background** if a stable value is reached (Figure 2). For a sample containing 30 ppb PTSA, the measured PTSA should be stabilized within the range of 29– 31 ppb.

*** NOTE*** *The time required to reach a stable reading may be slightly longer if the water sample temperature is significantly different than the environmental temperature at which the SP-350RO had been equilibrated (stored).*

6.2 High Color and Turbidity Warning









The SP-350RO has extra channels to measure sample turbidity and color to automatically compensate sample color and turbidity interference. If sample turbidity and color values determined are too high, a PTSA measurement warning will be displayed. In such a case, the user should filter the sample for PTSA measurement.

7 Calibration

7.1 PTSA Calibration (Two-Point with Zero)

1. Rinse the sample cell three times with DI water. Fill the sample cell with DI water.

*** NOTE*** *In emergency, "non-PTSA" water, such as city water, may be used, but re-calibrate using DI water for the zero step as soon as it is available.*

2. Power on the SP-350RO by pressing . Allow 5– 10 seconds for the SP-350RO to stabilize.
3. The unit is actively reading and displaying PTSA. The values will be very low if DI water is used; PTSA value should be near zero. A low non-zero value (e.g., 0.2 or 0.4, etc.) is not problematic.
4. Press **P-Cal** ( or ) to launch the **PTSA CALIBRATION** screen (Figure 3).
5. Press **Zero** () to start the zero (blank) calibration.
6. If the calibration succeeds, a checkmark () and instructions for the slope calibration will appear (Figure 4).
7. Rinse the sample cell three times with 30ppb PTSA standard. Fill the sample cell with 30ppb PTSA standard.
8. Press **Slope** () to start the slope calibration.
9. If the calibration succeeds, a checkmark (), a "**Calibration Success**" message will appear (Figure 5). Otherwise, a warning message is displayed.
10. Calibration is now complete. Press **Exit** () to return to measurement mode.

*** NOTE*** *If **Exit** is pressed before the second checkmark appears, the calibration will not be completed and must be re-done.*



Figure 3.



Figure 4.

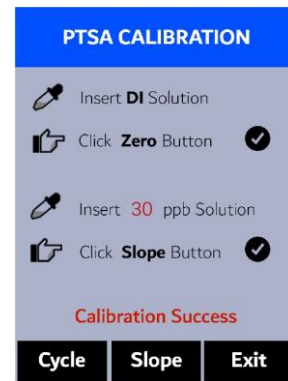



Figure 5.

8 Device Information and Diagnosis

The **DEVICE INFORMATION** screen is launched when **System** () is pressed in the measurement mode. This screen contains the device serial number, software version, and hardware version (Figure 6). The battery life as a percentage and the MAC addresses for main module also shown.

Press **Diagnosis** () to launch the **SYSTEM DIAGNOSIS** screen where raw measurement data are displayed (Figure 7). The information has no use for normal operation, but instead is used for device troubleshooting. Provide an image of both the **DEVICE INFORMATION** screen and the **SYSTEM DIAGNOSIS** screen when you contact Pyxis (service@pyxis-lab.com) for troubleshooting your device or call +1 (866) 203-8397.



Figure 6.

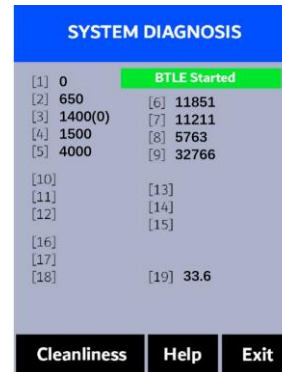

Figure 7.

8.1 Sample Cell Cleanliness Check

The SP-350RO is designed to provide reliable and accurate measurement on PTSA. Heavy fouling will prevent the light from reaching the sensor, resulting in inaccurate readings. It is suggested that the SP-350RO be checked for fouling and cleaned on a monthly basis. Heavily contaminated waters may require more frequent cleanings. Cleaner water sources with less contamination may not require cleaning for several months. The SP-350RO is designed to carry out a Cleanliness Check as described below:

1. Power on the SP-350RO by pressing **OK**.
2. Press **System** (**OK**) to launch the **DEVICE INFORMATION** screen.
3. Press **Diagnosis** (**<**) to launch the **SYSTEM DIAGNOSIS** screen.
4. Allow 5– 10 seconds for the message in the top-right corner of the display change from **Starting BTLE...** to **BTLE Started**.
5. Press **Cleanliness** (**<**). An instruction prompt appears to ask the user to put DI water into the sample cell (Figure 8).
6. Pour DI water into the sample cell.
7. Press **Confirm** (**<**, **>**, or **OK**). The instruction prompt will disappear and the SP-350RO displays a countdown toward the bottom of the display.
8. Once the Cleanliness Check is completed a **Clean** message (Figure9) or **Sample cell fouled** message (Figure 10) will appear towards the bottom of the display.
9. Cleanliness check is now complete. Press **Exit** (**OK**) to return to measurement mode.

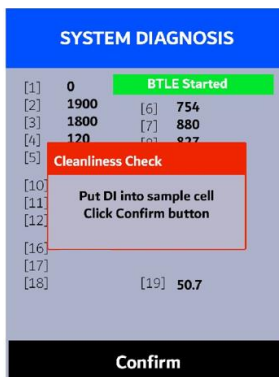

Figure 8.

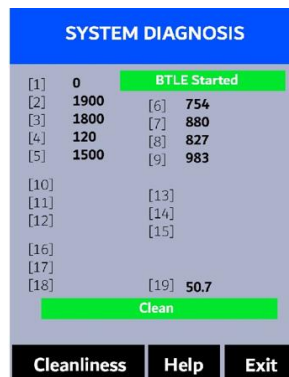

Figure 9.

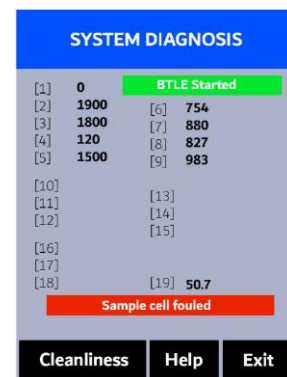





Figure 10.









8.2 Bluetooth Connection to Devices

The SP-350RO uses a built-in Bluetooth Low Energy Connection (BTLE) to connect wirelessly to a smart phone via the **uPyxis®** Mobile App or to a computer via the included Bluetooth Adapter (P/N: MA-NEB) and the **uPyxis®** Desktop App. To allow the SP-350RO to connect via Bluetooth with other devices follow the steps below:

1. Power on the SP-350RO by pressing .
2. Press **System** () to launch the **DEVICE INFORMATION** screen.
3. Press **Diagnosis** () to launch the **SYSTEM DIAGNOSIS** screen.
4. Allow 5– 10 seconds for the message in the top-right corner of the display change from **Starting BTLE...** to **BTLE Started** (Figure 7).
5. Choose to connect via one of two options:
 - (a) The **uPyxis®** Mobile App (see the **Use with uPyxis® Mobile App** section), or
 - (b) The **uPyxis®** Desktop App (see the **Use with uPyxis® Desktop App** section).

8.2.1 Calibrate an ST-500 Series Sensor with the SP-350RO via Bluetooth

The SP-350RO can be used to verify the result of an inline Pyxis ST-500 Series sensor by measuring the sample water taken from the inline sensor sample line. The SP-350RO can then be used to calibrate the inline sensors over the Bluetooth connection. To calibrate an inline sensor, follow the steps below:

1. Power on the SP-350RO by pressing **OK** ().
2. Press **System** () to launch the **DEVICE INFORMATION** screen.
3. Press **Comm** () to launch the **COMMUNICATION** screen (Figure 11).
4. Press **Scan** () to begin scanning for Bluetooth devices.
5. Discoverable devices will begin to populate on the display with their name and MAC-Address (Figure 12).
6. If more than one device appears in the **Device list**, press » () to cycle through the devices.
7. If no devices or the incorrect device appear in the **Device list**, press **Scan** () to re-scan for discoverable devices.
8. Press **Connect** () to begin pairing to the selected sensor.
9. When the connection is established, the SP-350RO displays the latest PTSA measurement from the connected sensor (Figure 13).
10. Fill the main module sample cell with the same sample water that the sensor is measuring.
11. Press **Read** () to see PTSA measurement from the SP-350RO along with the sensor measurement (Figure 14).
12. Press **Calib** () to begin sensor PTSA calibration.
13. The SP-350RO will take the sensor PTSA measurement three times to verify the calibration (Figure 15).



NOTE *It takes about one minute for the sensor to approach the calibrated reading and the three verifying readings may not be exactly the same as the value measured by the SP-350RO press **Read** () again to take more readings from the sensor, if necessary.*
14. If the calibration is successful, a “Verify calibration - OK” message will appear on the top of the display (Figure 16).
15. Calibration is now complete. Long press **Calib** () to return to measurement mode.



Figure 11.



Figure 12.

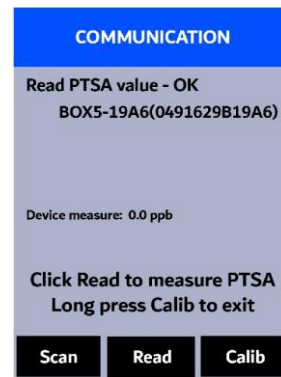

Figure 13.



Figure 14.

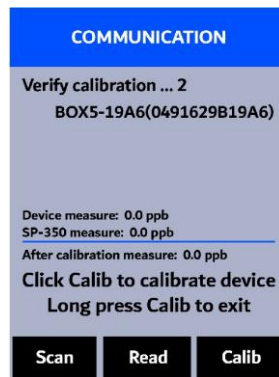

Figure 15.



Figure 16.

8.3 Factory Reset

Use the following steps to restore all device parameters to factory default:

1. Power on the SP-350RO by pressing **OK**.
2. Press **System** (**OK**) to launch the **DEVICE INFORMATION** screen.
3. Press **Diagnosis** (**<**) to launch the **SYSTEM DIAGNOSIS** screen.
4. Allow 5– 10 seconds for the message in the top-right corner of the display change from **Starting BTLE...** to **BTLE Started**.
5. Press **Help** (**>**) to launch the **HELP** screen (Figure17).
6. Press **Factory Reset** (**<** or **>**). The display updates as shown in Figure 18 appear and the user can choose one of three options:
 - (a) Press **OK** to start the factory reset, or
 - (b) Press **Cancel** (**<**) to return to the **HELP** screen, or
 - (c) Press **Exit** (**>**) to abandon the factory reset entirely.
7. After a successful factory reset, the message “Factory reset done.” will appear on the display.
8. Press **Exit** (**OK**) to return to measurement mode.



Figure 17.



Figure 18.

9 Use with uPyxis® Mobile App

9.1 Download uPyxis® Mobile App

Download uPyxis® Mobile App from [Apple App Store](#) or [Google Play](#).



Figure 19. uPyxis® Mobile App installation

9.2 Connecting to uPyxis® Mobile App

Connect the SP-350RO sensor to a mobile smart phone according to the following steps:

1. Follow the steps in the **Bluetooth Connection to Devices** section to make the SP-350RO discoverable.
2. Open **uPyxis®** Mobile App.
3. On **uPyxis®** Mobile App, pull down to refresh the list of available Pyxis devices.
4. If the connection is successful, the SP-350RO and its Serial Number (SN) will be displayed (Figure 20).
5. Press on the **SP-350RO image**.

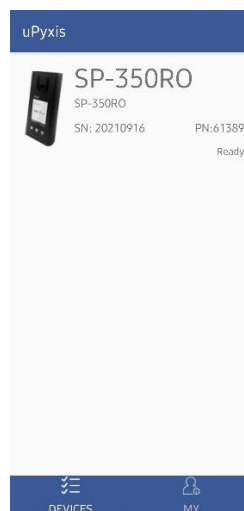

Figure 20.

9.3 Setting Screen

When connected, the uPyxis® Mobile App will default to the **Setting** screen. From the **Setting** screen, the user can set the **Power off time** and **Screen off time** in seconds. Be sure to press **Apply Settings** to save any changes.

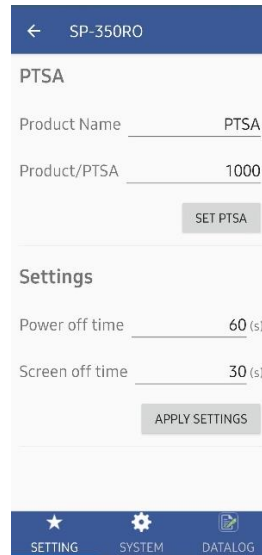

Figure 21.

9.4 System Screen

From the **System** screen, users can change the **Device Name**, find the **Serial Number**, **Hardware Version**, and **Firmware Version**, as well as update the firmware of the SP-350RO by pressing **Check Update**. If a firmware update is available, press **Download**. Once the new firmware is downloaded, press **Upgrade**.

NOTE *The firmware update process takes some time and will require the SP-350RO to stay within range (approximately 10 ft without obstructions) for the entire duration of the update.*

Once the update is complete, the SP-350RO will reboot which will disconnect the SP-350RO from the **uPyxis®** Mobile App.

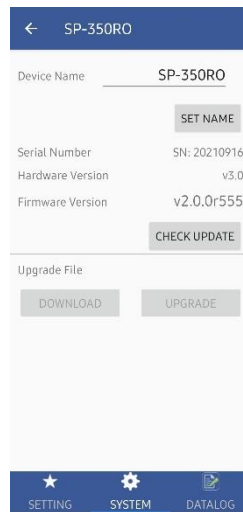

Figure 22.

10 Use with uPyxis® Desktop App

[uPyxis® Desktop App installation]

10.1 Install uPyxis® Desktop App

Download the latest version of **uPyxis®** Desktop software package from: <https://pyxis-lab.com/upyxis/>this setup package will download and install the Microsoft.Net Framework 4.5 (if not previously installed on the PC), the USB driver for the USB-Bluetooth adapter (MA-NEB), the USB-RS485 adapter (MA-485), and the main **uPyxis®** Desktop application. Double click the **uPyxis.Setup.exe** file to install.

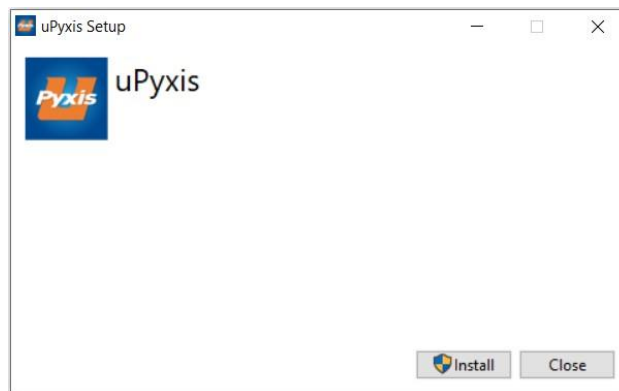

Figure 23. uPyxis® Desktop App installation

Click **Install** to start the installation process. Follow the screen instructions to complete the USB driver and uPyxis installation.

10.2 Connecting to uPyxis® Desktop App

Connect the SP-350RO to a Windows computer using a Bluetooth/USB adapter (P/N: MA-NEB) according to the following steps:

1. Follow the steps in the **Bluetooth Connection to Devices** section to make the SP-350RO discoverable.
2. Plug the Bluetooth/USB adapter into a USB port in the computer.
3. Launch **uPyxis®** Desktop App.
4. On **uPyxis®** Desktop App, click **Device** → **Connect via USB-Bluetooth** (Figure 24).
5. If the connection is successful, the SP-350RO and its Serial Number (SN) will be displayed in the left pane of the **uPyxis®** window.



MA-NEB

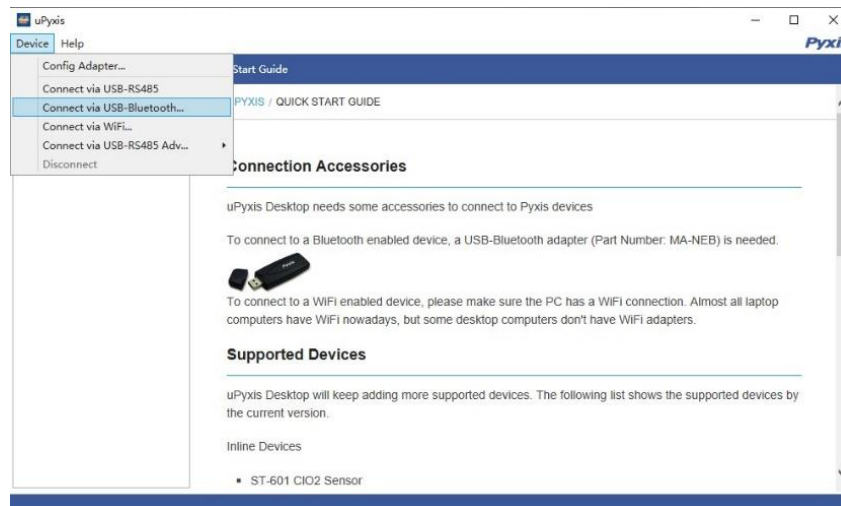

Figure 24.

10.3 System Screen

Once connected to the device, a picture of the device will appear on the top-left corner of the window and the **uPyxis**® Desktop App will default to the **System** screen. From the **System** screen, users can upgrade the firmware by selecting an appropriate firmware file (contact service@pyxis-lab.com for these firmware files) and clicking **Upgrade Firmware**.

NOTE *The firmware update process takes some time and will require the SP-350RO to stay within range (approximately 10ft without obstructions) for the entire duration of the update.*

Once the update is complete, the SP-350RO will reboot which will disconnect the SP-350RO from the **uPyxis**® Mobile App.

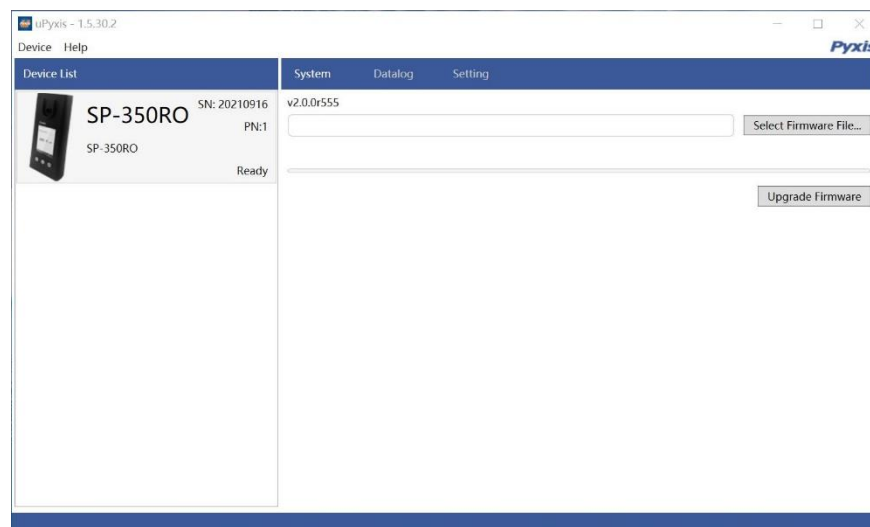

Figure 25.

10.4 Datalog Screen

From the **Datalog** screen, the user can view, delete, and export the internal log files of the SP-350RO by clicking **Read Datalog List** and selecting the desired datalog+ (these are separated by month). The SP-350RO will then populate any relevant log event from the selected datalog which can be viewed in more detail by clicking **Read Datalog**, deleted by clicking **Delete**, or exported by clicking **Export as .CSV File**.

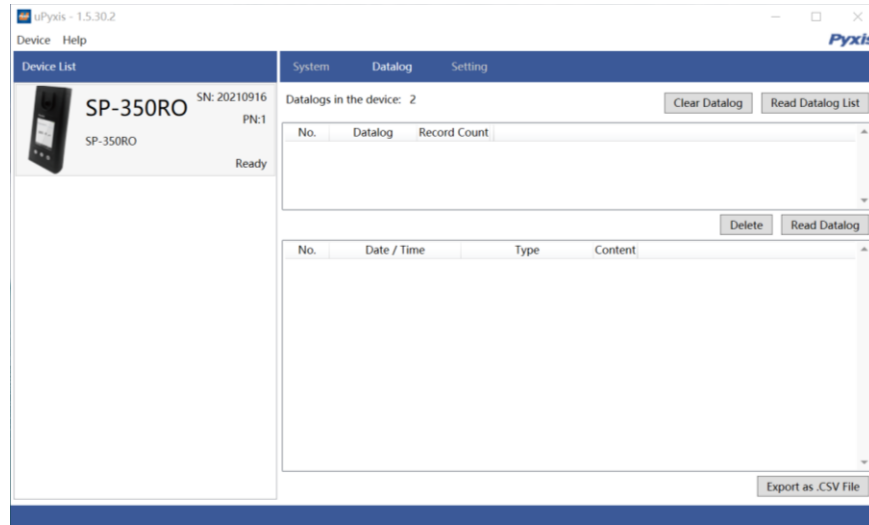

Figure 26.

10.5 Setting Screen

From the **Setting** screen, the user can set the **Power off time** and **Screen off time** in seconds. Be sure to press **Apply Settings** to save any changes.

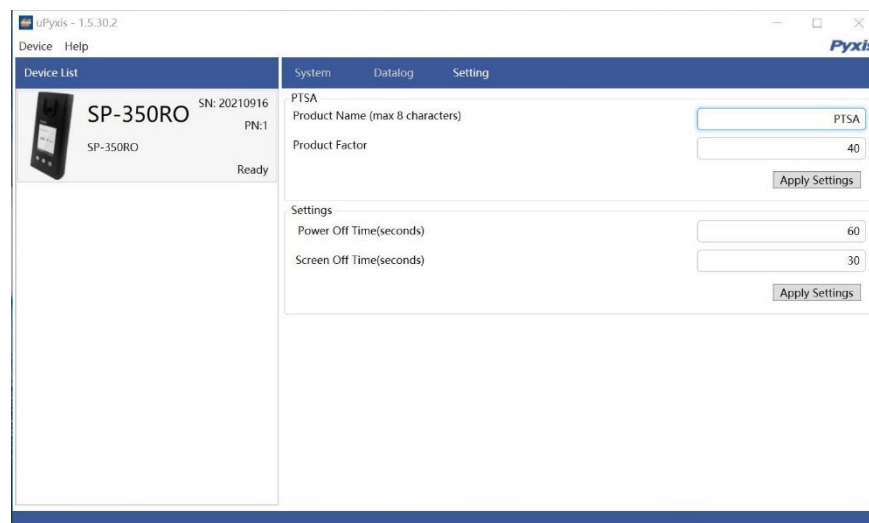

Figure 27.

11 Device Maintenance and Precaution

11.1 Maintenance Best Practices and Quick Tips

For greatly increased working life and ease of use of the SP-350RO follow the list of maintenance best practices and quick tips below:

- Rinse the sample cell at least three times with the desired solution before turning on.
- After a successful calibration, the unit does not automatically return to the measurement mode. If Exit is held down too long the unit will power down rather than returning to the measurement mode.
- After returning to measurement mode after calibration, rinse several times with the first sample. The unit will continue to read the sample values without any further key presses if it has not powered off. If there are no key presses for 20 seconds the screen will darken, and after another 20 seconds without key activity will power down. The press of any key while the screen is dark will reset the timer and the screen will re-light. (This press will not step along the calibration process; the next press needed will still be required in the sequence).
- Always rinse the unit with clean water after use and dry by clean tissue or paper towel.

11.2 Methods to Cleaning the SP-350RO

A light deposit on quartz glass inside the conductivity cell can be cleaned by a Q-tip. Aged heavy deposition, especially iron oxide deposited, can be removed using a cleaning solution that is capable of removing iron, such as the Pyxis Handheld Device Cleaning Solution Kit (P/N: SER-02) available from Pyxis online E-Store <https://pyxis-lab.com/product/handheld-device-cleaning-kit/>.



Figure 28. Handheld Device Cleaning Solution Kit

To clean the SP-350RO pour cleaning solution into the sample cell for 10 minutes. Rinse the sample cell with distilled water and use the Cleanliness Check (see the **Sample Cell Cleanliness Check** section) to confirm that the SP-350RO is clean. Repeat the process as needed until the Cleanliness Check shows **Clean**.

11.3 Storage

Do not expose the SP-350RO to an extreme high or low temperature condition such as leaving the SP-350RO inside an unattended automobile.

12 Contact Us

Pyxis Lab, Inc

1729 Majestic Dr. Suite 5
Lafayette, CO 80026 USA

www.pyxis-lab.com

Phone: +1 (866) 203-8397

Email: service@pyxis-lab.com