

ST-774 Porta-Panel Ultra-Low Dissolved Oxygen Analyzer User Manual



November 2022

Contents

1. Specifications	3
1.1. ST-774 Porta-Panel Overview + Specification (P/N 42096).....	3
2. Unpackaging	7
3. 4-20mA Output Wiring	8
4. Sample and Calibration Gas Connection	8
4.1. Sample Water Connection	8
4.2. Calibration Gas Connection.....	8
5. UC-50 Operation	9
5.1. Main Screen	9
5.2. Button Functions	10
5.3. System Information	10
5.4. Calibration	11
5.4.1. Zero Calibration Using Sulfite ZERO Calibration Kit (P/N 16019).....	11
5.4.2. Alternative Zero Calibration Using Pure Nitrogen Calibration Gas (99.999% or better)	13
5.4.3. Slope Calibration	13
5.5. 4-20 mA Output Setting	14
5.6. Historical Data and Historical Trend	14
5.7. USB Operation.....	15
5.7.1. Export Historical Data.....	15
5.7.2. Upgrade UC-50 Firmware.....	16
5.7.3. Adjust Historical Data Log Interval	16
Contact Us	18

1. Specifications

Please reference the ST-774 operation manual for the full specifications on the ultra-low dissolved oxygen sensor.

1.1. ST-774 Porta-Panel Overview + Specification (P/N 42096)

Product Description

The ST-774 Porta-Panel (P/N-42096) is a prefabricated panel ideally suited for those desiring to use the ST-774 Ultra-Low DO sensor with local display and data acquisition in a portable fashion for oxygen measurement (ie. deaerator performance studies). The Porta-Panel is pre-mounted on an easy-carry self-standing 316L stainless-steel panel with the ST-774 sensor, flow-cell and appropriate water sample/calibration gas flow hardware. The panel comes equipped with an integrated UC-50 Display/Data Logging Terminal for connected to the ST-774 via RS-485 Modbus offering live data display, calibration interface and data logging of the sensor. The UC-50 offers 1x contact relay output and has RS-485 Modbus and 1x 4-20mA outputs for passing the sensor value onto another device. The UC-50 also offers Bluetooth 5.0 capability for those desiring to use the uPyxis mobile or desktop apps for wireless calibration and diagnostics of the Pyxis sensor connected.



Above – Panel Front
Below – Panel Rear

Product Features

- Ideal for Dissolved Oxygen Studies
- Portable Free-Standing Panel – 316L SS
- Fully Integrated Plumbing + Flow Cell
- Measurement of Water Sample or Calibration Gas
- Premounted ST-774 Ultra-Low DO Sensor
- 0.0-2,000 $\mu\text{g/L}$ measurement range
- 0.1 $\mu\text{g/L}$ Lower Limit of Detection
- Built-in temperature and pressure sensors
- Premounted UC-50 Data Logger + Display Panel
- Direct RS-485 Modbus Connection to UC-50 Display
- Fully Integrated Zero + Slope Calibration Interface
- Simple Zero Calibration with Catalyzed Sulfite
- Integrated 4-20mA + RS-485 Output
- 1x Contact Alarm Relay and USB Data Logger



ST-774 Porta-Panel Diagram (mm)

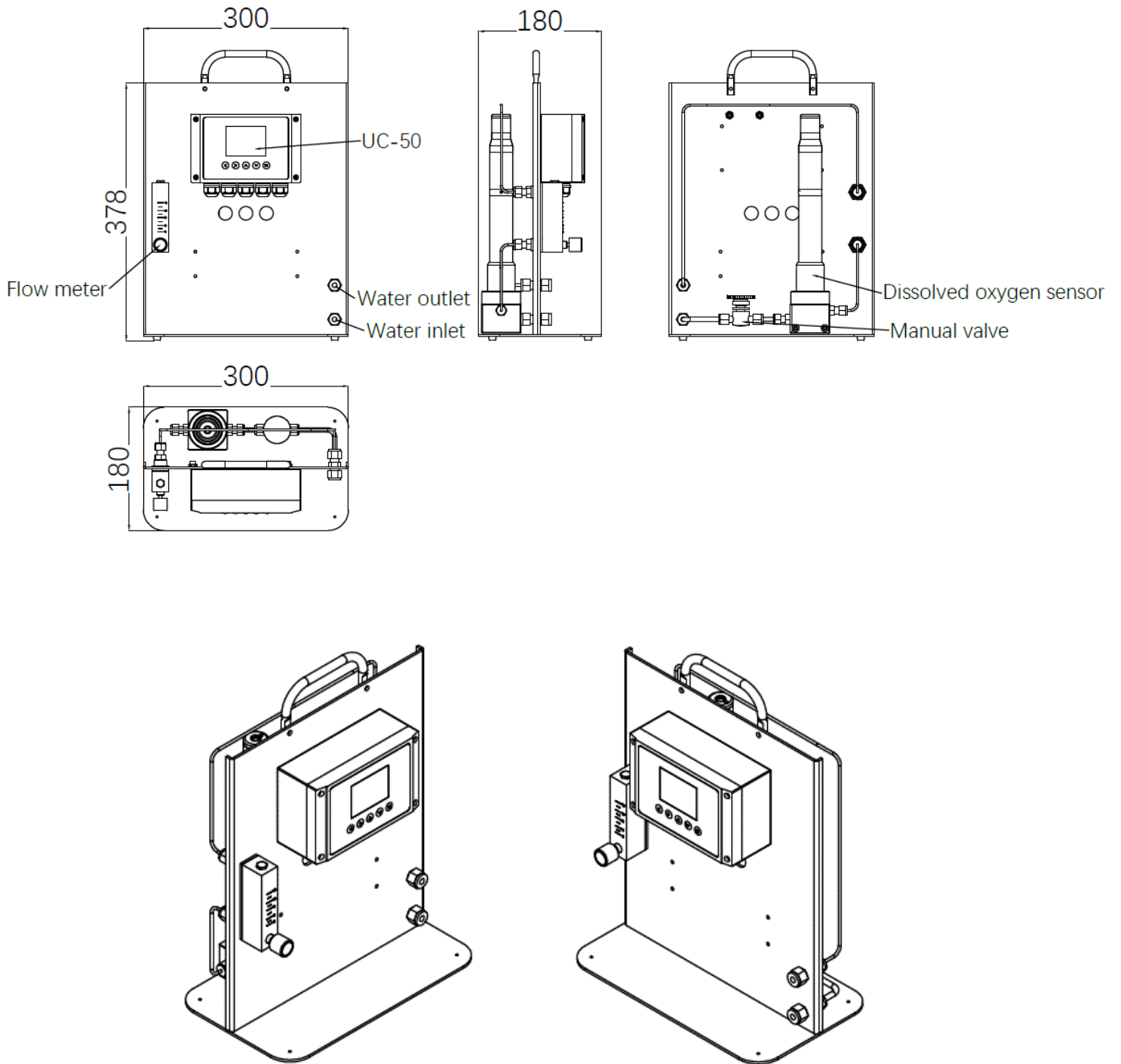

Figure 1 - ST-774 Porta-Panel (P/N-42096)

ST-774 Description

The Pyxis ST-774 is an ultra-low range dissolved oxygen (DO) sensor with a lower limit of detection 0.1 ppb ($\mu\text{g/L}$). Its design is based on the principle of fluorescence quenching to determine the partial pressure of the dissolved oxygen in water and incorporates Pyxis' advanced technology in the field of fluorescence detection. The Pyxis ST-774 offers the robustness associated with optical DO sensor technology while achieving the ultra-low detection limit compatible to an amperometric DO sensor. The ST-774 measures the oxygen partial pressure that is at equilibrium with the dissolved oxygen in water governed by Henry's law ($DO/ppb = K PO_2$). The embedded process control board within the ST-774 uses the latest USGS equations to convert the built-in partial pressure and temperature measured to a DO value in ppb (or $\mu\text{g/L}$).

The ST-774 offers an easily replaceable, front loading DO membrane cap (DCC-02) that has been independently developed by Pyxis Lab, with a typical service life of up to two years. The flat front-end design of the ST-774 makes this platform less prone to contamination or fouling and is very easy to clean. The sensor body is composed of 316L stainless steel and is well suited for aggressive industrial application use. The ST-774 sensor is connected via RS-485 Modbus output when packaged on the ST-774 Porta-Panel (P/N 42096) portable dissolved oxygen analyzer.

ST-774 Sensor Specifications



Figure 2
ST-774 DO Sensor
w/Flow Cell

Item	ST-774
P/N	53715
Measuring Range	0.00 - 2,000 $\mu\text{g/L}$ (ppb)
Limit of Detection (LOD)	0.1 $\mu\text{g/L}$ (ppb)
Resolution/Repeatability	0.1 $\mu\text{g/L}$ (ppb)
Accuracy	$\pm 0.3 \mu\text{g/L}$ (ppb) or $\pm 1\%$, whichever is greater
Light Source	Blue Light Exc / Red Light Emm
Response Time (90%)	<30s Liquid Phase / <10s Gas Phase
Operational Temperature	0 °C – 50 °C (32 - 122° F)
Operating Voltage	22 – 26V DC, Power 0.6W
Signal Output	4-20mA analog output / RS-485 digital output
Dimension (L x D)	300 x 60mm (11.8 x 2.36 inches)
Sensor Weight	2150 g (4.74 lb) cable excluded
Total Panel Weight	7257 g (16 lb)
Suggested Flow Range	50 – 500 mL/Minute
Sample Connection Format	Sample Line & Inlet Stainless Steel with Compression Fitting
Material	316L stainless steel
Working Pressure	145psi (10Bar)
Wet Material	316L stainless steel / PVC and polycarbonate
Calibration	In field Using Calibration Gas or Sulfite
DCC-02 Cartridge Life	Up to 2 years
Protection / Regulation	IP-67 / IP-68 / CE / RoHS

UC-50 Description

The Pyxis UC-50 is a preconfigured push-button color micro-display and data logging terminal that can connect any Pyxis sensor via RS-485, 4-20mA or Bluetooth 5.0 connectivity. This microprocessor-based display requires no configuration when connected to Pyxis inline sensors. When Pyxis sensors are landed via RS-485 modbus, the UC-50 immediately recognizes the sensor for live sensor value, color trend charts as well as sensor diagnostics and calibration interface while logging data for USB download. The UC-50 provides RS-485 and 1x 4-20 mA outputs as well as one 24 VDC alarm relay output for connection to additional controllers, PLC or DCS systems. The UC-50 is premounted as part of the ST-774 Porta-Panel Dissolved Oxygen Analyzer.



Figure 3
UC-50 Display + Data
Logging Terminal

Specifications

Item	UC-50
P/N	43007
Power	110/220VAC 50/60 Hz, 0.6A
Display	2.8" Color 320 x 240 Resolution
Output	1 x 4-20 mA / RS-485 Modbus-RTU
Input	1 x 4-20 mA / RS-485 Modbus-RTU
Relay Output	One channel relay output – 24VDC/10Watt Maximum
Data Storage	32M Flash
USB	1 x USB host for data downloading
Dimension	6.3 inch L x 3.9 inch W x 2.6 inch D
Weight	4.6 lbs / 2.1 kg
Operation Temperature	32 – 122 °F (-0 – 50 °C)
Storage Temperature	-4 – 158 °F (-20 – 70 °C)
Humidity	5 – 95% No Condensation
Protection	IP-65
BlueTooth	BlueTooth 5.0 - Capable of Reading Pyxis Bluetooth Sensors
Regulation	CE, RoHS

Order Information

ST-774 Porta-Panel (*Portable Panel Mounted ST-774 w/Flow Cell + UC-50 Data Logger*)

P/N

42096

Optional Accessories Information

ST-774 Flow Cell Assembly (*316L Flow Cell w/SwageLok For Spare Use or Replacement*)

P/N

53718

DCC-02 (*Replacement Dissolved Oxygen Membrane Cap for ST-774*)

53716

Sulfite ZERO Calibration Kit (*Includes Calibration Cap and 10mL Sulfite Powder*)

16019

Replacement Catalyzed Sodium Sulfite Powder in 10mL vial

SO3-VIAL

ST-774 SERVICE SWAP PROGRAM – ANNUAL

ST-774-SWAP

UC-50 (*UC-50 Micro Display + Data Logging Terminal*)

43007

NOTE - PO# must be issued for ST-774 Service-Swap Program. Pyxis Ships New/Reconditioned ST-774 Sensor Only. Client Ships Their Sensor to Pyxis for Even Exchange. 30-days to Ship Old Sensor or Pyxis Bills for full value of New ST-774

2. Unpackaging

The package includes the following items mounted on the panel

- ST-774 Porta-Panel Dissolved Oxygen Analyzer System (P/N 42096)
 - 316L Portable Panel with ¼" SS Tubing Swagelok and Micro Rotameter
 - ST-774 DO Sensor with DCC-02 Cap Installed with flow cell
 - Premounted – Prewired – Preconfigured UC-50 Display/Data Logging Terminal

3. 4-20mA Output Wiring

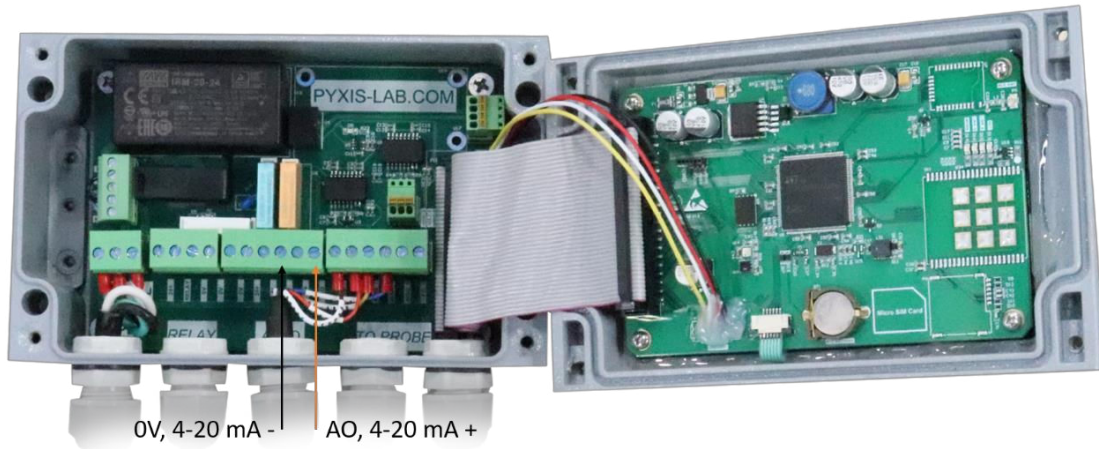

Figure 4. 4-20mA Output Wiring

4. Sample and Calibration Gas Connection

4.1. Sample Water Connection

Connect the sample to the water inlet port via a ¼ Swagelok tubing fitting and operate at a flow of 50-500mL/minute for optimum accuracy. To ensure a sample free of oxygen ingress, only compression style fittings (ie. Swagelok) and stainless steel sample tubing should be used. Never use plastic tubing for the sample line or threaded fittings or oxygen ingress may occur. With proper installation using stainless steel sample lines and thoroughly tightened compression fittings, the ST-774 should stabilize to a low level within a few hours after startup. Once this has occurred, you may proceed with the oxygen study/evaluation. If stabilization of the sensor takes a longer period of hours or days, please evaluate your installation for oxygen ingress into the sample line and other on-site application parameters (ie. deaerator operating temperature, pressure, feedwater flow rates, loss of oxygen scavenger feed etc.)

Tightly connect the cooled sample water inlet to the bottom sample in line. Connect the outlet flow line to drain. Note, the outlet flow line can utilized poly tubing if desired. Ensure the pre-inlet valve is in the open position. Slowly open the inlet valve allowing cooled sample to enter the inline rotameter. Adjust inlet sample flow to a range of 50-500mL/minute on the rotameter. Allow your ST-774 sensor to stabilize by observing the display value on the UC-50 display/data logging terminal. Your ST-774 comes precalibrated from the Pyxis production facility and should not need calibration or maintenance for a period of up to one year with proper use.

4.2. Calibration Gas Connection

For users desiring to calibrate the ST-774 sensor with calibration gas, prior to connecting the calibration gas to the sample inlet port on the bottom right of the panel via a ¼ inch Swagelok fitting, be sure to open the pre-sensor valve to allow gas flow to drain. Adjust rotameter to the open position allowing calibration gas to pass by the ST-774 sensor.

Ultrapure nitrogen gas (Pyxis DCC-3 P/N 42059) may be used for the zero calibration. The slope calibration requires 0.02% to 0.1% (or 200 to 1000 ppm) oxygen in nitrogen gas (Pyxis DCC-4 P/N 42060). Portable standard calibration gas cylinders can be purchased from Pyxis if desired in the United States only, or are commonly available on the open market. See Section 5.4.2 and 5.4.3 for details. ***NOTE*** *Pyxis does not provide the C-10 regulating valve for gas cylinders.*

For low pressure applications users may also conduct ZERO calibration of the ST-774 sensor with 5% cobalt catalyzed sodium sulfite solution. See Section 5.4.1 for details.

As an alternative and far faster/easier option, Pyxis Lab offers **ST-774 SERVICE SWAP** (P/N ST-774 SWAP). This service provides the user with a new or reconditioned ST-774 sensor calibrated and ready for service in exchange for the unit in need for calibration/service removed from the system. Contact Pyxis Lab for details at service@pyxis-lab.com.

5. UC-50 Operation

5.1. Main Screen

The UC-50 is configured to read and display measurement data from the Pyxis ST-774 dissolved oxygen probe. The system time, ST-774 DO ppb reading and the sample temperature measured by the ST-774 are displayed on the main screen. The green dot on the upper right of the screen indicates normal communication between the UC-50 and the ST-774 probe. In the bottom of the screen, the analog input (AI) value, the analog output (AO) value, and the relay status are shown.

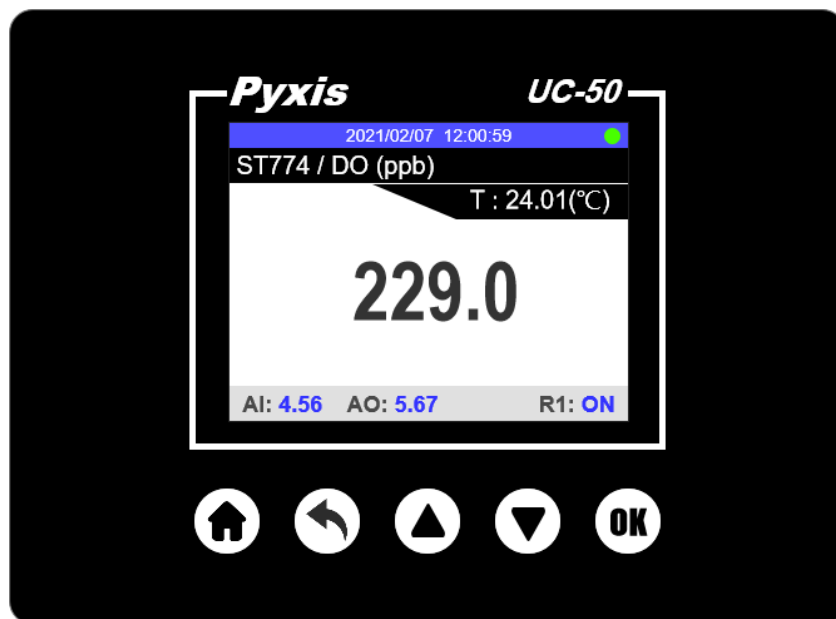

Figure 5. Main Screen

5.2. Button Functions

The house button on the left is for returning to the main screen from any screens. The left arrow button (second from the left) is for returning to the previous screens. The up and down buttons are for selecting items on the screen by moving the selection focus up, down, left, or right. The up and down buttons are also used to enter a numerical input. Single click or hold on these two buttons will increase or decrease the numerical value in the selected input fields. The OK button is for the selection confirmation, like the enter key on a computer keyboard.

5.3. System Information

Click the left arrow button to launch the system settings screen. Use the down button to select **System Information**. The UC-50 serial number, the hardware version and software version are shown in the System Information screen. Use the down button to highlight the Time field. Reset date or time if necessary.

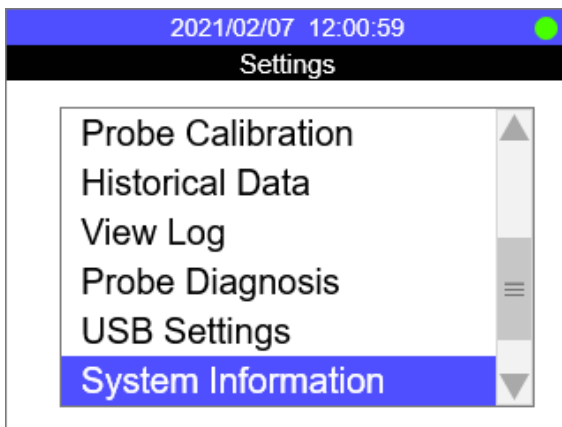

Figure 6. Settings

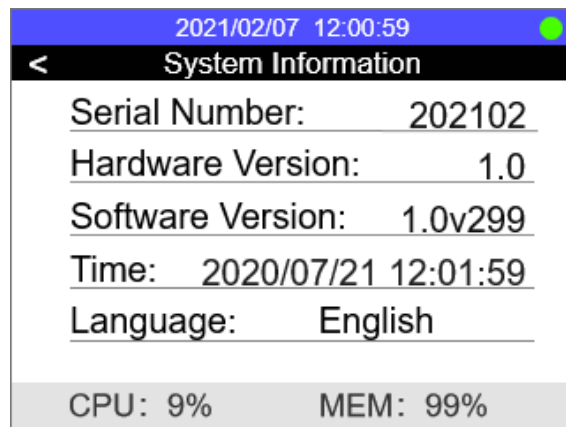

Figure 7. System Information

5.4. Calibration

5.4.1. Zero Calibration Using Sulfite ZERO Calibration Kit (P/N 16019)

- 1) Unscrew the lid from the 10mL vial containing catalyzed sodium sulfite powder (P/N - SO3 VIAL).
- 2) Fill the vial with DI water to the 10mL mark
- 3) Screw the lid on the vial and gently shake for 10 seconds.
- 4) Remove the Sulfite Zero Calibration Cap from packaging.
- 5) Unscrew the lid from the 10mL vial and pour the solution into the calibration cap.



- 6) Rotate the calibration cap slowly over the front of the sensor. ***NOTE*** any excess calibration fluid will flow out from the overflow port.

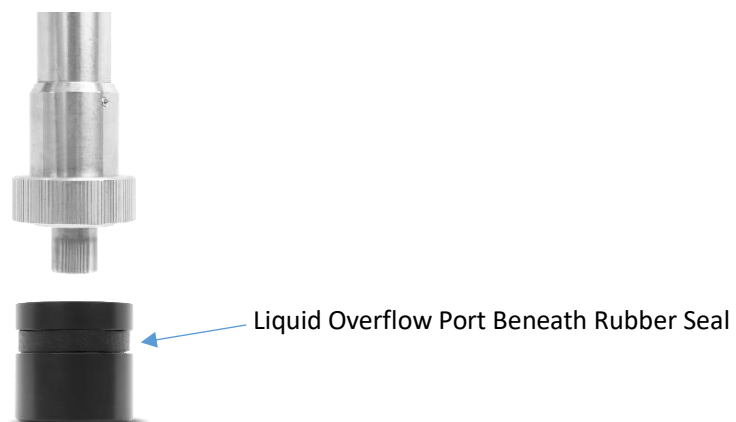

7) Place sensor in upright position with calibration cap at the bottom.



8) Select **Probe Calibration** from the Settings screen as shown in Figure 6. Then select **Zero cal** as shown in Figure 8.

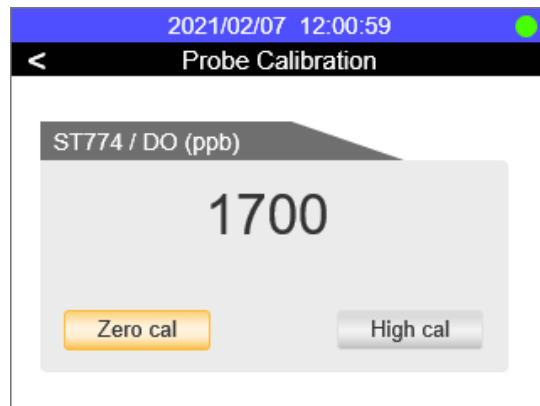
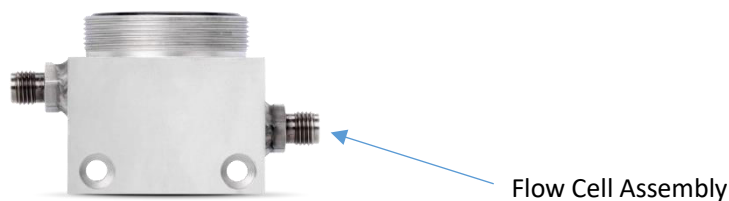

Figure 8. Zero Calibration

9) Select **Zero Cal** button and press OK to start the zero calibration on the UC-50. Allow the sensor with calibration cap / sulfite solution stand for up to 12 hours for best results.

10) After the 12-hour period, remove the calibration cap from the ST-774 sensor and rinse the sensor tip with DI water and insert sensor back into the ST-774 Flow Cell Assembly for service.



5.4.2. Alternative Zero Calibration Using Pure Nitrogen Calibration Gas (99.999% or better)

A depressurized nitrogen gas source can be connected to the sample cell through the 1/4" OD stainless tubing for the zero-point calibration. The gas flow rate should be regulated between 2 and 10 liter per minute.

NOTE Ensure the stainless-steel compression fittings are very tight and always use stainless steel OD tubing.

- 1) Ensure the ST-774 is tightly installed into the ST-774 Flow Cell Assembly.
- 2) Turn on a nitrogen gas flow and adjust flow to recommended rate of 2-10 Liters per minute.
- 3) Allow the gas flow and the temperature to be stabilized for 15 minutes. ***NOTE*** *Zero calibration using pure nitrogen gas at proper flow rates with tight fittings is more rapid than using catalyzed sulfite solution.*
- 4) Once the displayed oxygen and temperature values are stable, press **Zero Cal** to perform a zero calibration of the probe.
- 5) If the calibration is successful, the interface will return a message "Calibration Succeeded". If the calibration fails, press **Zero Cal** again and repeat.

5.4.3. Slope Calibration

Select **Probe Calibration** from the screen shown in Figure 6. Using the same techniques as outlined for zero gas calibration, establish an oxygen containing calibration gas (Pyxis DCC4 = 99.9% Nitrogen / 0.1% Oxygen Gas Cylinder) flow for 15 minutes or until the ppb reading has stabilized. Select **High Cal** and press OK to start the slope calibration. Use the UP/DOWN buttons and OK button to enter the specific oxygen percentage concentration in the calibration gas being used. If the slope calibration is complete, a calibration succeed message will be prompted.

NOTE - *the value shown in Figure 9 is the oxygen percentage in the calibration gas, not the dissolved oxygen concentration in ppb or ppm. The ST-774 probe will automatically convert the oxygen percentage concentration along with the measured barometric pressure and temperature to the precise dissolved oxygen concentration in ppb or ppm during the calibration process.*

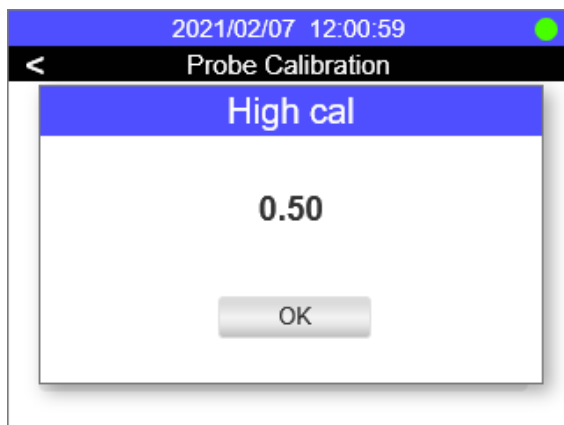

Figure 9. High (slope) Calibration

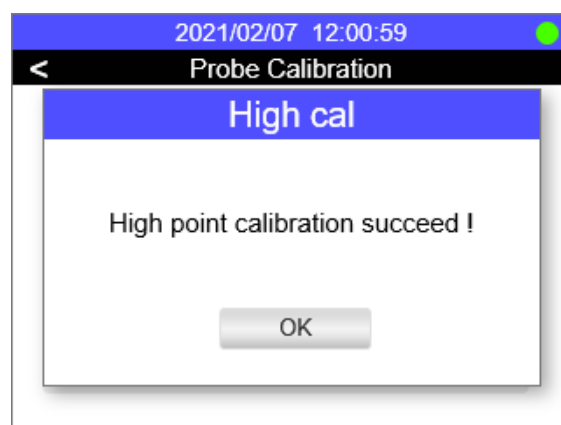

Figure 10. Calibration Succeed

5.5. 4-20 mA Output Setting

Select **Probe Settings** from the Settings screen. Change the 4-20 mA scale via interface shown in Figure 12. The unit for DO is ppb ($\mu\text{g/L}$).

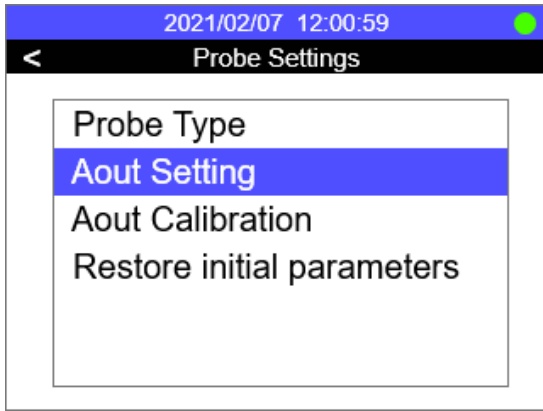

Figure 11. Probe Setting

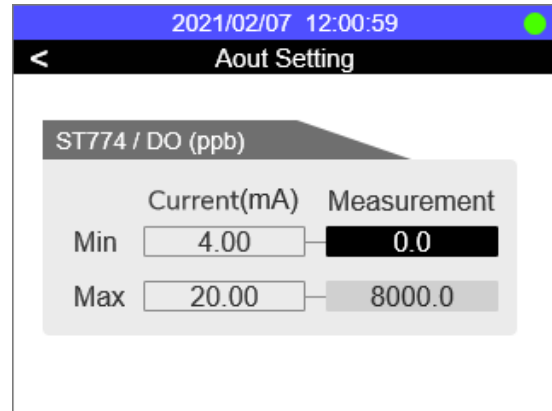

Figure 12. Setup 4-20 mA output scale

5.6. Historical Data and Historical Trend

Use the left arrow button to launch the **Settings** screen. Select **Historical Data** or **Historical Trend** to view screen shown in Figures 13 and 14. The historical data is recored every minute as a default, however this may be adjusted, see Section 5.7.3 for details. ***NOTE*** The data trend chart is not in real-time. When the trend chart screen is launched, the recorded data is charted with a 6 minute delay. The historical data can be uploaded to a USB driver in CSV format as outlined in Section 5.7

The screenshot shows a mobile application interface with a blue header bar displaying the date and time '2021/02/07 12:00:59'. Below the header is a black bar with a left arrow and the text 'Historical Data'. The main content area is a white box with a table of recorded data. The table has two columns: 'Time' and 'DO(ppb)'. The data is as follows:

Time	DO(ppb)
2021/02/07 12:59	1234.56
2021/02/07 12:58	1234.55
2021/02/07 12:57	1234.56
2021/02/07 12:56	1234.55
2021/02/07 12:55	1234.56
2021/02/07 12:54	1234.55
2021/02/07 12:53	1234.56
2021/02/07 12:52	1234.55
2021/02/07 12:51	1234.56

Figure 13. Recorded Historical Data

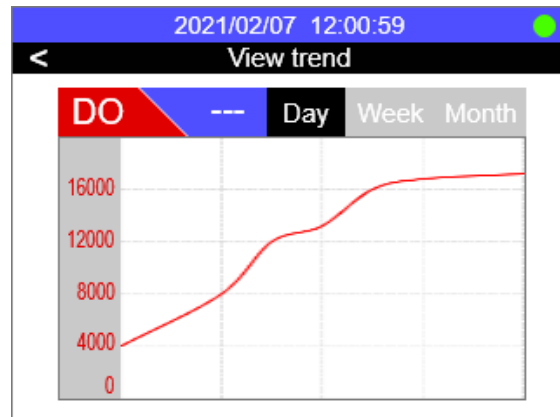

Figure 14. Historical Trend Chart

The ppb range of the trend chart can be configured via interface shown in Figures 15 and 16.

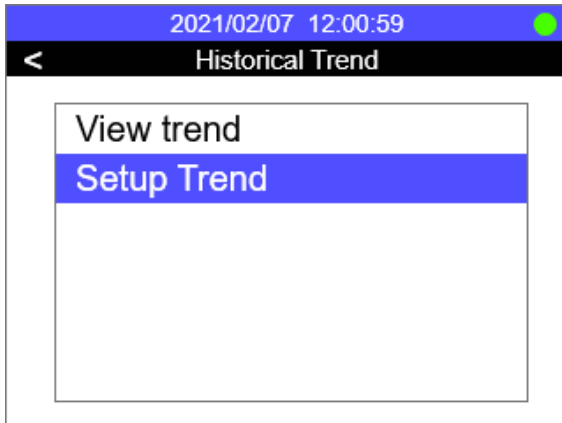

Figure 15. Trend Chart Setup

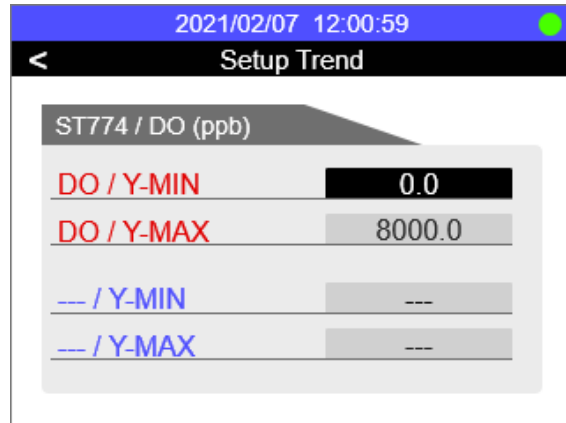

Figure 16. Y-Axis Range Setup

5.7. USB Operation

UC-50 has a built-in USB interface to support historical data export and firmware upgrade function. Before accessing USB functions, please make sure USB thumb drive is properly plugged into UC-50 USB interface.

NOTE For data download and upload to the UC-50 a USB device with a storage capacity between 8 and 64MB *Megabytes* is recommended.

5.7.1. Export Historical Data

Select **USB Settings** from the Settings screen. In the USB settings screen, historical data can be downloaded to a USB thumb driver by selecting Data Export function. Make sure a USB thumb drive is plugged into UC-50 before exporting historical data.

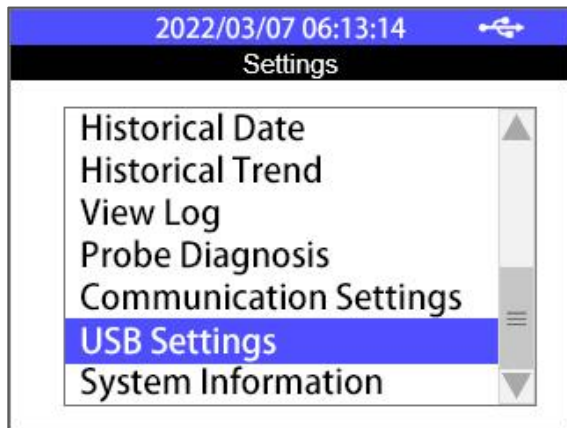

Figure 17. Select USB Settings

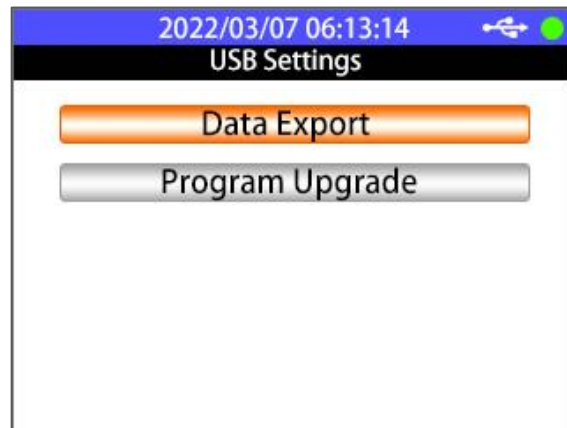

Figure 18. Select Data Export

Further select the historical data date and time range or simply choose All Export to export all historical data. Once data export 100% completed, you can safely unplug the USB thumb drive.

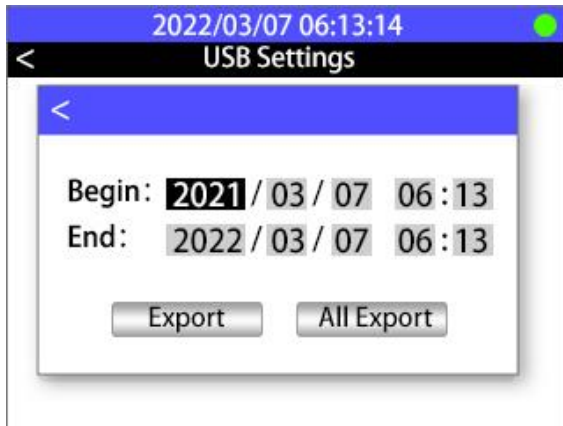

Figure 19. Specify Date & Time Range



Figure 20. Export Historical Data

5.7.2. Upgrade UC-50 Firmware

Copy the target UC-50 firmware file (.bin) to the root directory of USB thumb drive, plug the thumb drive to UC-50 USB interface, select **USB Settings** in Settings page and select the **Program Upgrade** function in USB Settings page. UC-50 will automatically start firmware upgrading procedure and reboot itself once the procedure completed.

5.7.3. Adjust Historical Data Log Interval

By default, UC-50 will save sensor value every 60 seconds to its internal data storage, if an application requires 3 months historical data export, UC-50 will generate over 10,000 lines of historical data if the historical data interval is set to 60 seconds. As seen in Figures 21 and 22, the UC-50 allows customer to adjust historical data interval to

- 1) Reduce exported historical data file size if high resolution data is not required
- 2) Capture high resolution data if sensor value changes rapidly

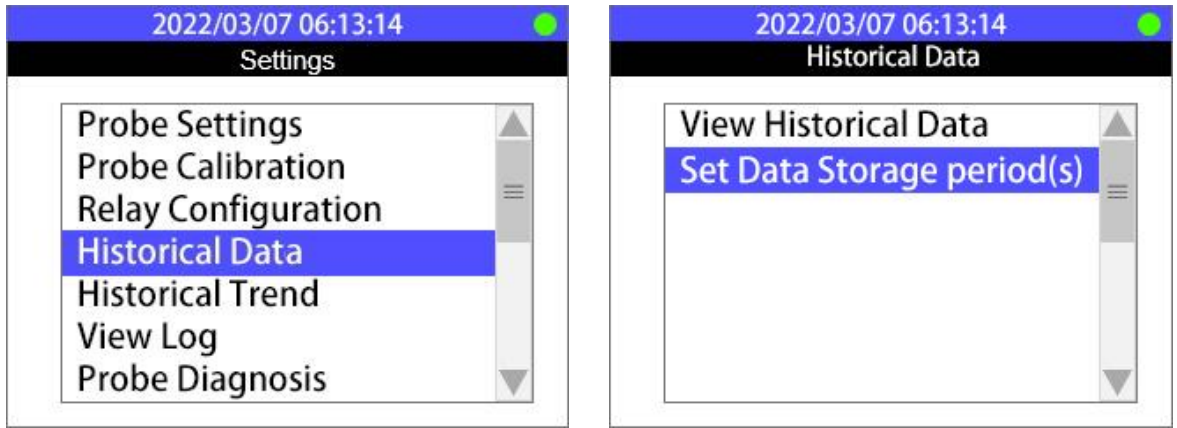

Figure 21. Adjusting Set Data Storage – Steps 1 and 2

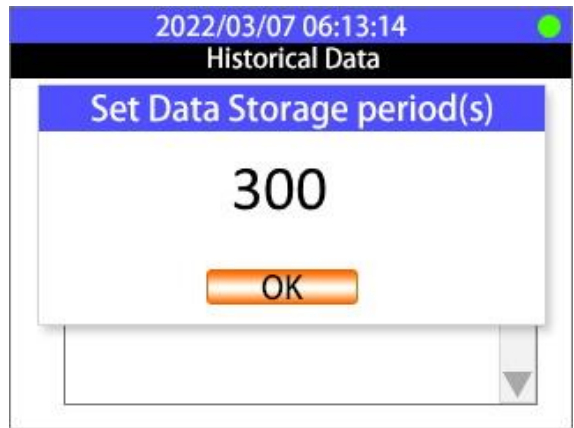
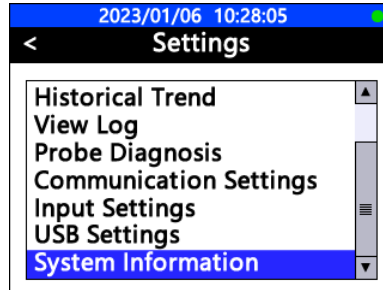

Figure 22. Adjusting Set Data Storage (Data Log Frequency in Seconds)

5.7.4. Adjusting Date & Time

1. Hit the **Main** Key
2. Hit the **Up** or **Down** Key until “System Information” is highlighted.
3. Hit the **OK** Key to enter the System Information Screen.
4. Hit the **Down** Key until the desired parameter is highlighted.
5. Hit the **OK** Key to select the desired parameter. The highlight should turn blue.



6. Push the **Up** or **Down** Key until the desired value is selected.
7. Hit the **OK** Key to confirm the new desired value.
8. Hit the **Main** Key to go back to the main screen.

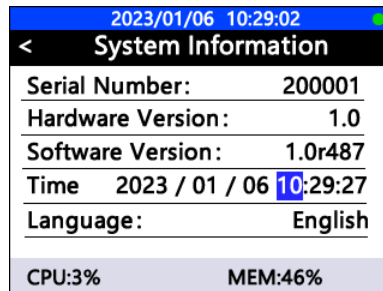

Contact us

Contact us if you have questions about the use or maintenance of the ST-774 sensor:

Pyxis Lab, Inc.

1729 Majestic Dr. Suite 5
Lafayette, CO 80026 USA
1-866-203-8397

www.pyxis-lab.com

service@pyxis-lab.com