

# Pyxis<sup>®</sup>

## LT-73X Series Inline Ultra-Low Turbidity Sensors User Manual

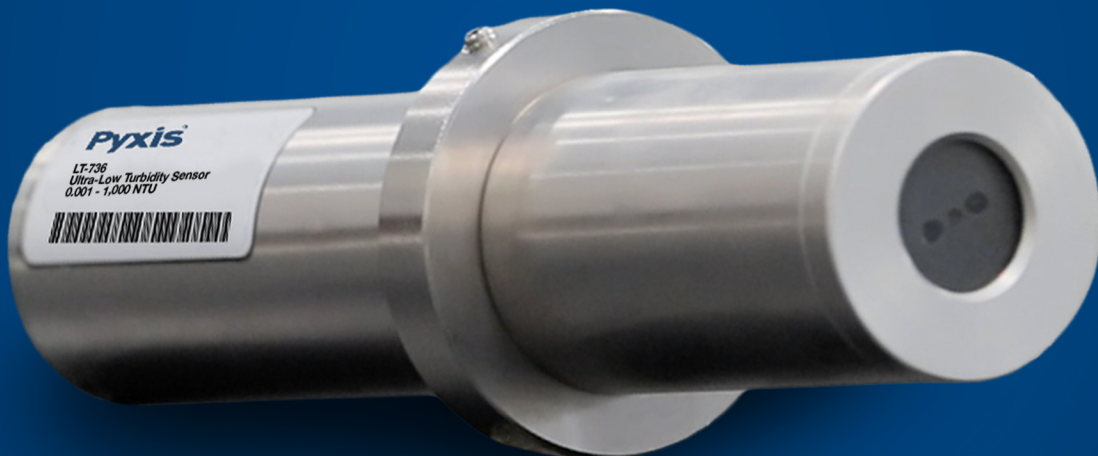

Water Professionals Deserve Better Tools.  
[www.pyxis-lab.com](http://www.pyxis-lab.com)

# LT-73X Series Ultra-Low Turbidity Inline Sensor User Manual

February 7, 2022  
Rev. 1.13

**Pyxis Lab, Inc.**  
1729 Majestic Dr. Suite 5  
Lafayette, CO 80026 USA  
[www.pyxis-lab.com](http://www.pyxis-lab.com)

## Table of Contents

<b>1</b>	<b>Introduction</b>	<b>2</b>
1.1	Main Features . . . . .	2
<b>2</b>	<b>Specifications</b>	<b>3</b>
<b>3</b>	<b>Unpacking Instrument</b>	<b>5</b>
3.1	Standard Accessories . . . . .	5
3.2	Optional Accessories . . . . .	5
<b>4</b>	<b>Installation</b>	<b>6</b>
4.1	FR-100 Flow Reservoir Assembly for Drinking Water Installation . . . . .	6
4.2	FT-100 Inline Tee Assembly Installation . . . . .	8
4.3	Wiring . . . . .	9
4.4	Connecting via Bluetooth . . . . .	10
<b>5</b>	<b>Setup and Calibration with uPyxis® Mobile App</b>	<b>10</b>
5.1	Download uPyxis® Mobile App . . . . .	10
5.2	Connecting to uPyxis® Mobile App . . . . .	11
5.3	Calibration Screen and Reading . . . . .	12
5.4	Diagnosis Screen . . . . .	15
5.5	Device Info Screen . . . . .	16
<b>6</b>	<b>Setup and Calibration with uPyxis® Desktop App</b>	<b>16</b>
6.1	Install uPyxis® Desktop App . . . . .	16
6.2	Connecting to uPyxis® Desktop App . . . . .	17
6.3	Information Screen . . . . .	18
6.4	Calibration Screen . . . . .	18
6.5	Diagnosis Screen . . . . .	22
<b>7</b>	<b>Outputs</b>	<b>22</b>
7.1	4–20mA Output Setup . . . . .	22
7.2	Adjusting 4–20mA Span . . . . .	23
7.3	Communication using Modbus RTU . . . . .	23
<b>8</b>	<b>Sensor Maintenance and Precaution</b>	<b>24</b>
8.1	Methods to Cleaning the LT-73X Series Sensor . . . . .	24
8.2	Storage . . . . .	25
<b>9</b>	<b>Troubleshooting</b>	<b>25</b>
<b>10</b>	<b>Contact Us</b>	<b>25</b>

## **Warranty Information**

### **Confidentiality**

The information contained in this manual may be confidential and proprietary and is the property of Pyxis Lab, Inc. Information disclosed herein shall not be used to manufacture, construct, or otherwise reproduce the goods described. Information disclosed herein shall not be disclosed to others or made public in any manner without the express written consent of Pyxis Lab, Inc.

### **Standard Limited Warranty**

Pyxis Lab warrants its products for defects in materials and workmanship. Pyxis Lab will, at its option, repair or replace instrument components that prove to be defective with new or remanufactured components (i.e., equivalent to new). The warranty set forth is exclusive and no other warranty, whether written or oral, is expressed or implied.

### **Warranty Term**

The Pyxis warranty term is thirteen (13) months ex-works. In no event shall the standard limited warranty coverage extend beyond thirteen (13) months from original shipment date.

### **Warranty Service**

Damaged or dysfunctional instruments may be returned to Pyxis for repair or replacement. In some instances, replacement instruments may be available for short duration loan or lease.

Pyxis warrants that any labor services provided shall conform to the reasonable standards of technical competency and performance effective at the time of delivery. All service interventions are to be reviewed and authorized as correct and complete at the completion of the service by a customer representative, or designate. Pyxis warrants these services for 30 days after the authorization and will correct any qualifying deficiency in labor provided that the labor service deficiency is exactly related to the originating event. No other remedy, other than the provision of labor services, may be applicable.

Repair components (parts and materials), but not consumables, provided during a repair, or purchased individually, are warranted for 90 days ex-works for materials and workmanship. In no event will the incorporation of a warranted repair component into an instrument extend the whole instrument's warranty beyond its original term.

### **Warranty Shipping**

A Repair Authorization (RA) Number must be obtained from Pyxis Technical Support before any product can be returned to the factory. Pyxis will pay freight charges to ship replacement or repaired products to the customer. The customer shall pay freight charges for returning products to Pyxis. Any product returned to the factory without an RA number will be returned to the customer. To receive an RMA you can generate a request on our website at <https://pyxis-lab.com/request-tech-support/>.

### **Pyxis Technical Support**

Contact Pyxis Technical Support at +1 (866) 203-8397, [service@pyxis-lab.com](mailto:service@pyxis-lab.com), or by filling out a request for support at <https://pyxis-lab.com/request-tech-support/>.

## 1 Introduction

The LT-73X Series sensor is an inline turbidity sensor in the ranges of 0.001 to 1,000 NTU with an ultra-fine resolution and meeting ISO-7027 (850 nm LED) and EPA-180.1 (warm white LED) compliance guidelines. The quartz plate front surface in the LT-73X Series sensor allows for extended cleanliness and easy maintenance. This sensor is designed for optimal precision and performance in a wide range of turbidity using a 90° surface scatter configuration. The sensor can be installed in two flow assembly formats (**FR-100 Flow Reservoir Assembly** or **FT-100 Inline Tee Assembly**), making it versatile for a variety of drinking or industrial water applications. It is powered by a 24 VDC/1.5 W power supply and provides both 4–20 mA and RS-485 Modbus output signals. When clean, the unique Pyxis sensor design offers a stability of <0.02 NTU for up to one year without calibration. Additionally, this sensor can be wirelessly accessed via MA-CR Bluetooth adapter for Diagnostics, Cleaning, and Calibration when using the **uPyxis®** Mobile or Desktop App.

### 1.1 Main Features

The LT-73X Series sensor includes the following features:

- Warm white (3200 K) or Infrared (850 nm) LED for long operational life
- Resolution as low as 0.001 NTU
- FR-100 Flow Reservoir Assembly available for all LT-73X Series sensors for optimum resolution
- FT-100 Inline Tee Assembly available for all LT-73X Series sensors for industrial applications
- Built-in transmitter, without preamplifier or meter head
- Combination 4–20mA isolated signal and RS-485 Modbus output
- Simple/wireless calibration using the MA-CR Bluetooth Adapter and **uPyxis®** Mobile or Desktop App
- Easily removed and cleaned without the need for tools
- Optional Ultrasonic Adapter for automatic cleaning (in development)
- Optional calibration with a Solid-State Calibration Kit (LT-SOLID-CAL Series)

## 2 Specifications

**Table 1.** LT-73X Series Specifications

Specification*	LT-736	LT-737	LT-739
Part Number (P/N)	53215	53216	53221
Turbidity Range	0.002–1000.00	0.001–5.000	0.001–40.00
Accuracy Using FR-100	<40 NTU: ±0.005 NTU or ±2% >40 NTU: ±0.02 NTU or ±2%	±0.005 NTU or ±1%	<10 NTU: ±0.005 NTU or ±2% >10 NTU: ±0.01 NTU or ±2%
Accuracy Using FT-100	<40 NTU: ±0.01 NTU or ±2% >40 NTU: ±0.05 NTU or ±2%	±0.01 NTU or ±1%	<10 NTU: ±0.01 NTU or ±2% >10 NTU: ±0.02 NTU or ±2%
Resolution Using FR-100	<40 NTU: ±0.001 NTU or ±0.5% >40 NTU: ±0.02 NTU or ±1%	±0.001 NTU or ±0.5%	<10 NTU: ±0.001 NTU or ±0.5% >10 NTU: ±0.01 NTU or ±1%
Resolution Using FT-100	<40 NTU: ±0.002 NTU or ±1% >40 NTU: ±0.05 NTU or ±1%	±0.002 NTU or ±1%	<10 NTU: ±0.002 NTU or ±1% >10 NTU: ±0.02 NTU or ±1%
Light Source (LED)	Warm White		
Compliance	EPA 180.1		
Calibration	Pyxis Solid State Calibration Kit for Repeatable Liquid-Less Calibration, Pyxis Formazin Standards & Dry Secondary Zero Standard for Field Cal = 0.01 Repeatability, Pyxis Lab Factory Ultra-Pure Calibration Services = 0.001 Repeatability		
Calibration Stability †	<0.02 NTU/year drift	<0.01 NTU/year drift	<0.02 NTU/year drift
Outputs	4–20mA Analog Output, RS-485 Digital Output with Modbus protocol		
Installation	<b>FR-100 Flow Reservoir Assembly:</b> 1/4" OD Tubing, <b>FT-100 Inline Tee Assembly:</b> 1.5" NPT Thread & Socket		
Cable Length	Standard MA-4.9CR Cable (8-Pin Extension – 4.9 ft), Flying Lead MA-1.5CR Cable (8-Pin Male Adapter/Flying Leads – 1.5 m)		
Power Supply	22–26 VDC, 1.5 W		
Dimension (L × Dia)	7.4 × 1.44 inch (189 × 36 mm)		
Material	304 Stainless Steel		
Operational Temperature	33.8–131°F (1–50 °C)		
Operational Pressure	LT-73X Series sensors: up to 100 psi (6.9 Bar), FR-100 Flow Reservoir: atmospheric pressure, FT-100 Inline Tee: up to 100 psi (6.9 Bar)		
Operational Flow Rate	LT-73X Series sensors: 0–40 L/min (0–10.6 GPM), FR-100 Flow Reservoir: 200–400 mL/min, FT-100 Inline Tee: 0–40 L/min (0–10.6 GPM)		
Enclosure Rating	IP67		
Regulation	CE		

\* With Pyxis’s continuous improvement policy, these specifications are subject to change without notice.

† Assuming sensor is clean

Table 2. LT-73XB Specifications

Specification*	LT-736B	LT-737B	LT-739B
Part Number (P/N)	53223	53224	53225
Turbidity Range	0.002–1000.00	0.001–5.000	0.001–40.00
Accuracy Using FR-100	<40 NTU: $\pm 0.005$ NTU or $\pm 2\%$ >40 NTU: $\pm 0.02$ NTU or $\pm 2\%$	$\pm 0.005$ NTU or $\pm 1\%$	<10 NTU: $\pm 0.005$ NTU or $\pm 2\%$ >10 NTU: $\pm 0.01$ NTU or $\pm 2\%$
Accuracy Using FT-100	<40 NTU: $\pm 0.01$ NTU or $\pm 2\%$ >40 NTU: $\pm 0.05$ NTU or $\pm 2\%$	$\pm 0.01$ NTU or $\pm 1\%$	<10 NTU: $\pm 0.01$ NTU or $\pm 2\%$ >10 NTU: $\pm 0.02$ NTU or $\pm 2\%$
Resolution Using FR-100	<40 NTU: $\pm 0.001$ NTU or $\pm 0.5\%$ >40 NTU: $\pm 0.02$ NTU or $\pm 1\%$	$\pm 0.001$ NTU or $\pm 0.5\%$	<10 NTU: $\pm 0.001$ NTU or $\pm 0.5\%$ >10 NTU: $\pm 0.01$ NTU or $\pm 1\%$
Resolution Using FT-100	<40 NTU: $\pm 0.002$ NTU or $\pm 1\%$ >40 NTU: $\pm 0.05$ NTU or $\pm 1\%$	$\pm 0.002$ NTU or $\pm 1\%$	<10 NTU: $\pm 0.002$ NTU or $\pm 1\%$ >10 NTU: $\pm 0.02$ NTU or $\pm 1\%$
Light Source (LED)	850 nm		
Compliance	ISO-7027		
Calibration	Pyxis Solid State Calibration Kit for Repeatable Liquid-Less Calibration, Pyxis Formazin Standards & Dry Secondary Zero Standard for Field Cal = 0.01 Repeatability, Pyxis Lab Factory Ultra-Pure Calibration Services = 0.001 Repeatability		
Calibration Stability <sup>†</sup>	<0.02 NTU/year drift	<0.01 NTU/year drift	<0.02 NTU/year drift
Outputs	4–20mA Analog Output, RS-485 Digital Output with Modbus protocol		
Installation	<b>FR-100 Flow Reservoir Assembly:</b> 1/4" OD Tubing, <b>FT-100 Inline Tee Assembly:</b> 1.5" NPT Thread & Socket		
Cable Length	Standard MA-4.9CR Cable (8-Pin Extension – 4.9 ft), Flying Lead MA-1.5CR Cable (8-Pin Male Adapter/Flying Leads – 1.5 m)		
Power Supply	22–26 VDC, 1.5 W		
Dimension (L × Dia)	7.4 × 1.44 inch (189 × 36 mm)		
Material	304 Stainless Steel		
Operational Temperature	33.8–131°F (1–50 °C)		
Operational Pressure	LT-73X Series sensors: up to 100 psi (6.9 Bar), FR-100 Flow Reservoir: atmospheric pressure, FT-100 Inline Tee: up to 100 psi (6.9 Bar)		
Operational Flow Rate	LT-73X Series sensors: 0–40 L/min (0–10.6 GPM), FR-100 Flow Reservoir: 200–400 mL/min, FT-100 Inline Tee: 0–40 L/min (0–10.6 GPM)		
Enclosure Rating	IP67		
Regulation	CE		

\* With Pyxis's continuous improvement policy, these specifications are subject to change without notice.

<sup>†</sup> Assuming sensor is clean



### 3 Unpacking Instrument

Remove the instrument and accessories from the shipping container and inspect each item for any damage that may have occurred during shipping. Verify that all accessory items are included. If any item is missing or damaged, please contact Pyxis Lab Customer Service at [service@pyxis-lab.com](mailto:service@pyxis-lab.com).

#### 3.1 Standard Accessories

- MA-4.9CR Cable (4.9 ft 8-Pin Male/Female Extension Cable) P/N: 50745
- MA-1.5CR Cable (1.5 m/4.9 ft 8-Pin Male Adapter/Flying Lead) P/N: 50746
- User Manual available online at <https://pyxis-lab.com/support/>

#### 3.2 Optional Accessories

The following optional accessories can be ordered at [order@pyxis-lab.com](mailto:order@pyxis-lab.com) or the Pyxis E-Store at <https://pyxis-lab.com/shop/>

**Table 3.** Optional Accessories

Accessory Name	Part Number (P/N)
FR-100 Flow Reservoir Assembly	50779
FT-100 Inline Tee Assembly	50780
MA-CR Bluetooth Adapter For Pyxis 8-Pin Sensors	MA-CR
MA-NEB USB Bluetooth Adapter For <b>uPyxis</b> ® Desktop	MA-NEB
MA-50CR Cable (15 m/50 ft 8-Pin Male/Female Extension Cable)	50743
LT-SOLID-CAL 736 (Solid State Calibration Kit for LT-736)	53229
LT-SOLID-CAL 737 (Solid State Calibration Kit for LT-737)	53227
LT-SOLID-CAL 739 (Solid State Calibration Kit for LT-739)	53228
LT-SOLID-CAL 736B (Solid State Calibration Kit for LT-736B)	53239
LT-SOLID-CAL 737B (Solid State Calibration Kit for LT-737B)	53237
LT-SOLID-CAL 739B (Solid State Calibration Kit for LT-739B)	53238
L-CAL Portable Liquid Formazin Calibration Kit	53247
Formazin 2.0 NTU Turbidity Calibration Standard — 4,000 mL	57010-2L
Formazin 5.0 NTU Turbidity Calibration Standard — 4,000 mL	57010-5L
Formazin 10 NTU Turbidity Calibration Standard — 4,000 mL	57010-10L
Formazin 30 NTU Turbidity Calibration Standard — 4,000 mL	57010-30L
Formazin 200 NTU Turbidity Calibration Standard — 4,000 mL	57010-200L
Formazin 500 NTU Turbidity Calibration Standard — 4,000 mL	57010-500L



## 4 Installation

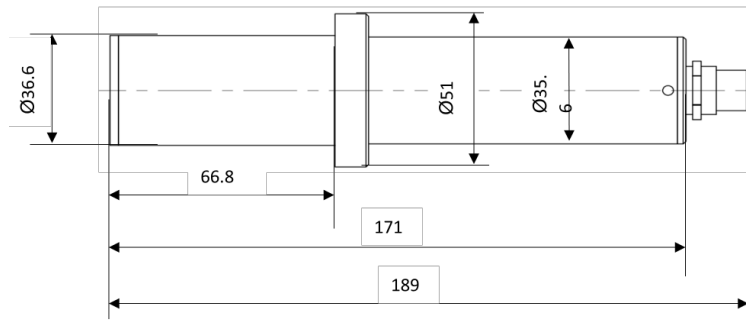

**Figure 1.** Dimension of the LT-73X Series sensor (mm)

### 4.1 FR-100 Flow Reservoir Assembly for Drinking Water Installation



**Figure 2.** LT-73X Series Sensor with FR-100 Flow Reservoir Assembly

For use in drinking water installations, the LT-73X Series ultra-low turbidity sensors should be installed using the Pyxis FR-100 Flow Reservoir Assembly. This uniquely designed reservoir operates in a by-pass format at a 200–400 mL/min flow rate and serves as a calming vessel. Specifically designed to reduce stray light interference, the FR-100 Flow Reservoir Assembly also allows for the elimination of air bubble entrainment, drop-out of large particulate and suspended solids including precipitated inorganics such as iron and manganese. The FR-100 Flow Reservoir Assembly comes wall- or panel-mountable and complete including 1/4" tubing inlet with isolation valve, pressure reducing valve, inline flow meter, 3/8" tubing sample output and overflow assembly as well as 1/2" NTP bottom blowdown ball valve for solids removal. The LT-73X Series sensors can be easily installed via the union adapter provided onto the side wall of the FR-100 Flow Reservoir Assembly. When emptied and cleaned, the FR-100 may also serve as a zero-point calibration check of the sensor. Replacement sensors or reservoirs may be purchased independently.

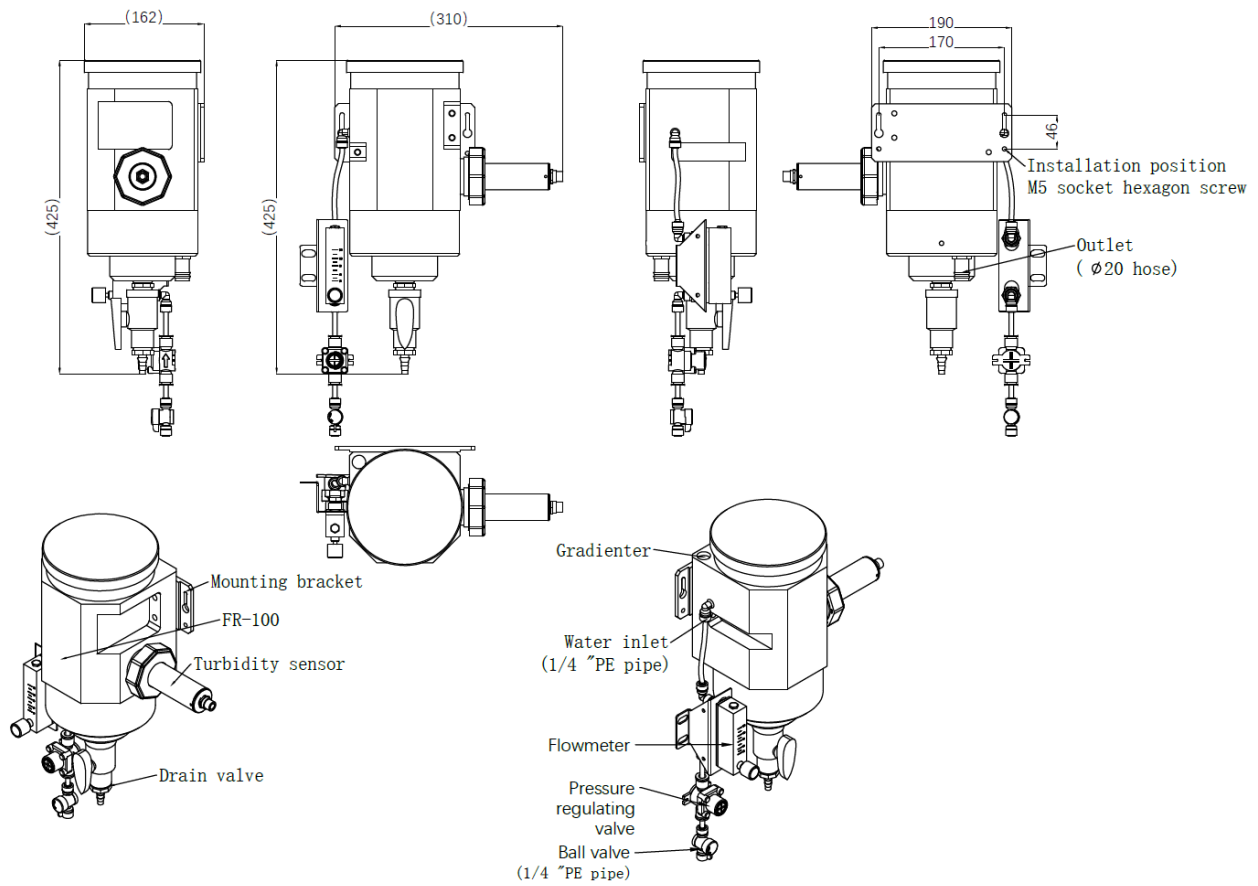

**Figure 3.** FR-100 Flow Reservoir Assembly Dimensions (mm) & Diagram



**Figure 4.** Top view of FR-100. Diffusers (6 each) are provided and can be randomly installed in overflow weir to help minimize air bubbles.

## 4.2 FT-100 Inline Tee Assembly Installation



Figure 5. LT-73X Series Sensor with FT-100 Inline Tee Assembly

For use in alternative installations, the LT-73X Series ultra-low turbidity sensors may also be installed using the Pyxis FT-100 Inline Flow Tee Assembly. This uniquely designed in-line Tee operates at up to 40 Liters/Min (10.6 GPM) flow rate and operating pressures as high as 6.9 bar (100 psi). Constructed of Schedule 40-CPVC and designed with a unique 45° downward angle for extended sensor cleanliness, the FT-100 in-line Tee assembly allows for users to install the LT-73X Series sensor in pressurized flow applications with limited space. This inline tee dramatically reduces the installation space requirement and is highly compatible with most by-pass sensor plumbing installations, allowing the user to easily remove the sensor for wireless cleaning and maintenance. The LT-73X Series sensor’s flat distillate end is specifically designed to prevent air bubbles from accumulating when installed in the FT-100. When emptied and cleaned, the FT-100 may also serve as a low range (zero-point) calibration of the sensor via the **uPyxis®** App. The FT-100 Inline Flow Tee Assembly offers 1.5” FNPT threaded and socket adapters with quick unions to allow for rapid installation or replacement. The FT-100 Inline Flow Tee Assembly may be purchased independently as desired.

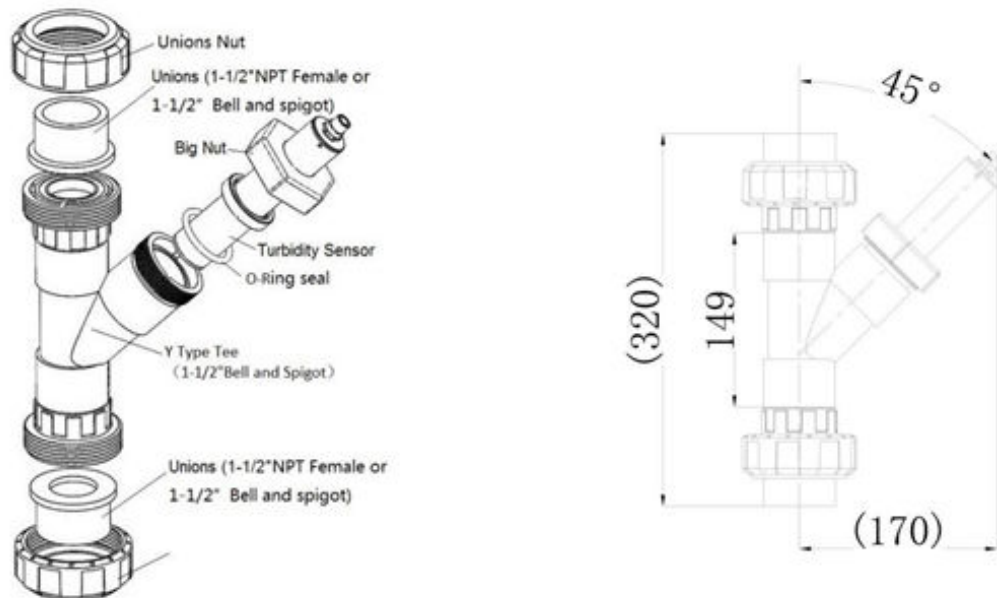

Figure 6. FT-100 Inline Tee Assembly Dimensions (mm) & Diagram

### 4.3 Wiring

If the power ground terminal and the negative 4–20mA terminal in the controller are internally connected (non-isolated 4–20mA input), it is unnecessary to connect the 4–20mA negative wire (gray) to the 4–20mA negative terminal in the controller. If a separate DC power supply other than that from the controller is used, make sure that the output from the power supply is rated for 22–26 VDC @ 65 mA.

**\*NOTE\*** *The negative 24V power terminal (power ground) and the negative 4–20mA terminal on the LT-73X Series sensor are internally connected.*

Follow the wiring table below to connect the LT-73X Series sensor to a controller:

**Table 4.**

Wire Color	Designation
Red	24V +
Brown	24V Power ground
White	4–20mA +
Gray*	4–20mA -
Blue	RS-485 A
Yellow	RS-485 B
Pink	RS-485 C
Green	Earth ground
Black	Shield

\* Internally connected to the power ground

#### 4.4 Connecting via Bluetooth

A Bluetooth adapter (P/N: MA-CR) can be used to connect a LT-73X Series sensor to a smart phone with the **uPyxis®** Mobile App or a computer with the **uPyxis®** Desktop App.

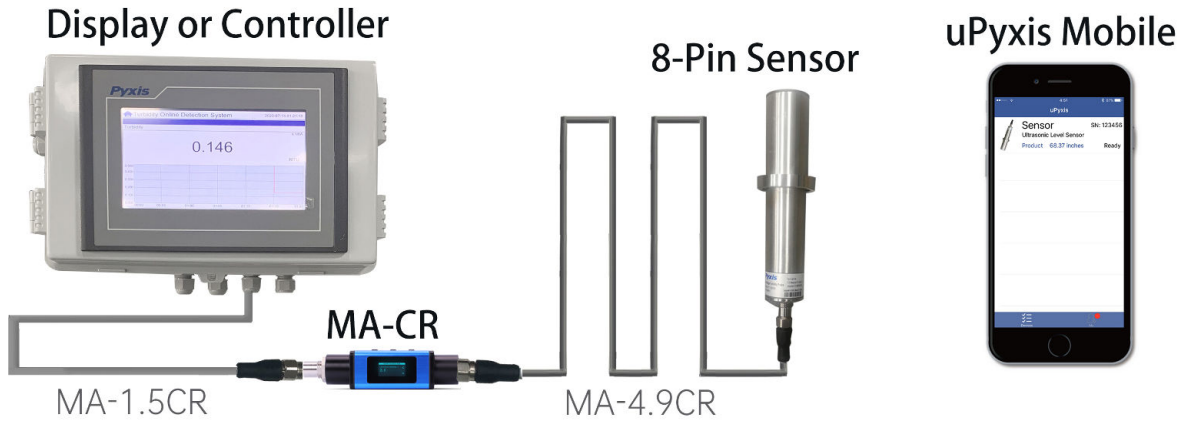

**Figure 7.** Bluetooth connection to LT-73X Series sensor with MA-CR and uPyxis Mobile App

## 5 Setup and Calibration with uPyxis® Mobile App

### 5.1 Download uPyxis® Mobile App

Download **uPyxis®** Mobile App from [Apple App Store](#) or [Google Play](#).

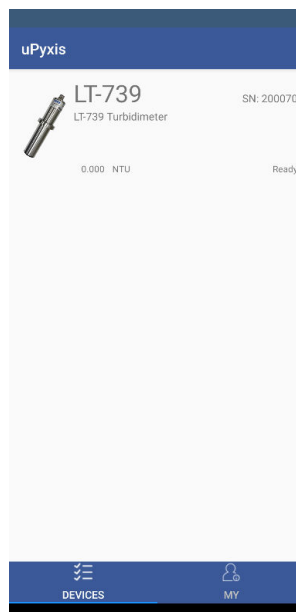

**Figure 8.** uPyxis® Mobile App installation

## 5.2 Connecting to uPyxis® Mobile App

Connect the LT-73X Series sensor to a mobile smart phone according to the following steps:

1. Open **uPyxis®** Mobile App.
2. On **uPyxis®** Mobile App, pull down to refresh the list of available Pyxis devices.
3. If the connection is successful, the LT-73X Series and its Serial Number (SN) will be displayed (Figure 9).
4. Press on the **LT-73X Series sensor image**.



**Figure 9.**

### 5.3 Calibration Screen and Reading

When connected, the uPyxis® Mobile App will default to the **Calibration** screen. From the **Calibration** screen, you can perform calibrations by pressing on **Low Range Calibration**, **Mid Range Calibration**, **High Range Calibration**, and **4–20mA Span**. Please refer to the following table for the recommended turbidity standard solution for each range:

**Table 5.** Recommended Formazin Calibration Standards

Calibration Range	LT-736/LT-736B	LT-737/LT-737B	LT-739/LT-739B
Near Zero/Low	Bubble-free DI or sample <0.1 NTU		
Mid	5–50 NTU	1–2 NTU	5–10 NTU
High	500–1000 NTU	3–5 NTU	20–40 NTU

**\*NOTE\*** Calibration of the LT-73X Series sensor may be conducted in the flow vessel itself (FR-100 or FT-100) or by using the L-CAL Portable Liquid Formazin Calibration Kit (P/N: 53247). Please contact Pyxis Lab for details and procedures on the L-CAL Kit as an alternative to using inline vessel for calibration allowing dramatically reduced volume of Formazin solution required.

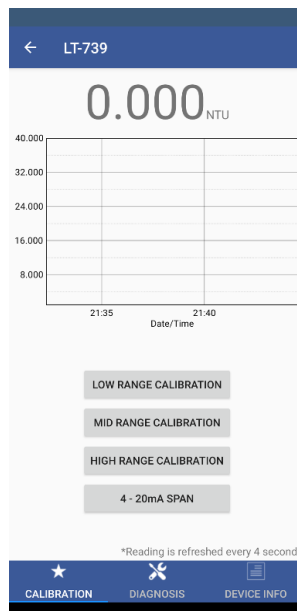

**Figure 10.**

#### 5.3.1 Low Range Calibration

1. Empty the FR-100 Flow Reservoir or FT-100 Tee.
2. Wipe the FR-100 Flow Reservoir or FT-100 Tee walls and the LT-73X Series sensor surface with a dust-free cloth and confirm there are no obvious contaminants.
3. Fill the FR-100 Flow Reservoir or FT-100 Tee with deionized (DI) water.
4. Use a brush or the dust-free cloth to clean the FR-100 Flow Reservoir or FT-100 Tee walls and the LT-73X Series sensor surface.



5. Thoroughly drain the polluted DI water.
6. Repeat steps 3–5 three times to ensure optimum cleanliness.
7. Fill the FR-100 Flow Reservoir or FT-100 Tee with bubble-free DI water.
8. Allow the displayed data to stabilize; this could take some time to eliminate air bubbles.
9. Press **Low Range Calibration** to begin the low range calibration.
10. Enter "0.05" for the known turbidity value.
  - \*NOTE\*** *Because there is no global standard for zero turbidity in the industry, Pyxis recommends 0.05 NTU as a target low range calibration using bubble-free DI water. Users may vary from this entry value if desired, however, a true "zero" turbidity calibration standard does not exist.*
11. If the calibration is successful, the interface will return a message "Calibration Succeeded". If the calibration has failed, the interface will return a message "Calibration Failed" and the user must repeat the process.

### 5.3.2 Mid Range Calibration

1. Conduct the Low Range Calibration steps above.
2. Empty the FR-100 Flow Reservoir or FT-100 Tee and refill with a known turbidity standard solution according to the **Recommended Formazin Calibration Standards** table.
3. Allow the displayed data to stabilize.
4. Press **Mid Range Calibration** to begin the middle range calibration.
5. Enter the known turbidity value.
6. If the calibration is successful, the interface will return a message "Calibration Succeeded". If the calibration has failed, the interface will return a message "Calibration Failed" and the user must repeat the process.

### 5.3.3 High Range Calibration

If the high range calibration is not required, the user does not need to calibrate the high range. To continue the high range calibration using a second turbidity standard solution, use the following steps:

1. Conduct the Mid Range Calibration steps above.
2. Empty the FR-100 Flow Reservoir or FT-100 Tee and refill with a known turbidity standard solution according to the **Recommended Formazin Calibration Standards** table.
3. Allow the displayed data to stabilize.
4. Press **High Range Calibration** to begin the middle range calibration.
5. Enter the known turbidity value.
6. If the calibration is successful, the interface will return a message "Calibration Succeeded". If the calibration has failed, the interface will return a message "Calibration Failed" and the user must repeat the process.

### 5.3.4 LT-SOLID-CAL Solid State Calibration

Alternatively, Pyxis Lab has developed reusable solid-state turbidity calibration kits for rapid calibration of the Pyxis LT-73X Series sensor. The LT-SOLID-CAL calibration kits represent an alternative to Formazin calibration for routine field calibration only. The Pyxis solid-state calibration kits provide a consistent and reproducible method to calibrate Pyxis LT-73X Series sensors, overcoming the challenges associated with the liquid standard calibration.

**Table 6.** LT-SOLID-CAL Calibration Kit Specifications for LT-73X Sensors

Specification	LT-SOLID-CAL 736	LT-SOLID-CAL 737	LT-SOLID-CAL 739
Part Number (P/N)	53229	53227	53228
Turbidities Included	0.10±0.05 NTU, 8.0±0.8 NTU, 25.0±2.5 NTU, 600±60 NTU	0.10±0.05 NTU, 1.5±0.15 NTU, 4.0±0.4 NTU	0.10±0.05 NTU, 8.0±0.8 NTU, 25.0±2.5 NTU

**Table 7.** LT-SOLID-CAL Calibration Kit Specifications for LT-73XB Sensors

Specification	LT-SOLID-CAL 736B	LT-SOLID-CAL 737B	LT-SOLID-CAL 739B
Part Number (P/N)	53239	53237	53238
Turbidities Included	0.10±0.05 NTU, 8.0±0.8 NTU, 25.0±2.5 NTU, 600±60 NTU	0.10±0.05 NTU, 1.5±0.15 NTU, 4.0±0.4 NTU	0.10±0.05 NTU, 8.0±0.8 NTU, 25.0±2.5 NTU

To calibrate the LT-73X Series sensor with the LT-SOLID-CAL kit, use the following steps:

1. Remove the LT-73X Series sensor from the FR-100 Flow Reservoir or FT-100 Tee.
2. Clean the LT-73X Series sensor surface gently with a soft towel.
3. Insert the LT-73X Series sensor into the appropriate T-CAL kit based on the **LT-SOLID-CAL Calibration Kit Specifications for LT-73X Sensors** and **LT-SOLID-CAL Calibration Kit Specifications for LT-73XB Sensors** tables.
4. Press either **Low Range Calibration**, **Mid Range Calibration**, or **High Range Calibration**.
5. Enter the designated NTU value assigned to the LT-SOLID-CAL kit for the known turbidity value.



**Figure 11.** LT-73X Series sensor use with LT-SOLID-CAL kit

## 5.4 Diagnosis Screen

From the **Diagnosis** screen, you can check the diagnosis condition as well as **Export & Upload**. This feature may be used for technical support when communicating with [service@pyxis-lab.com](mailto:service@pyxis-lab.com).

To perform a Cleanliness Check, first select the **Diagnosis Condition** which defines the fluid type that the LT-73X Series sensor is currently measuring, then press **Cleanliness Check**. If the sensor is clean, a **Clean** message will be shown. If the sensor is severely fouled, a **Dirty** message will be shown. In this case, follow the procedure in the **Methods to Cleaning the LT-73X Series Sensor** section of this manual.

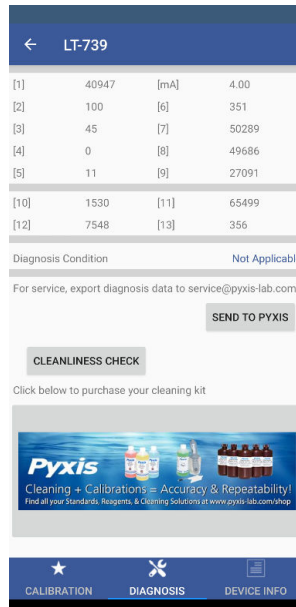

Figure 12.

### 5.5 Device Info Screen

From the **Device Info** screen. You can name the Device or Product.

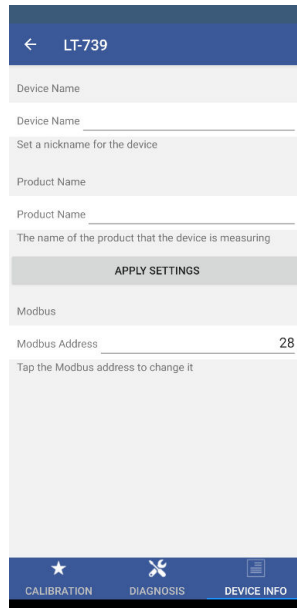

Figure 13.

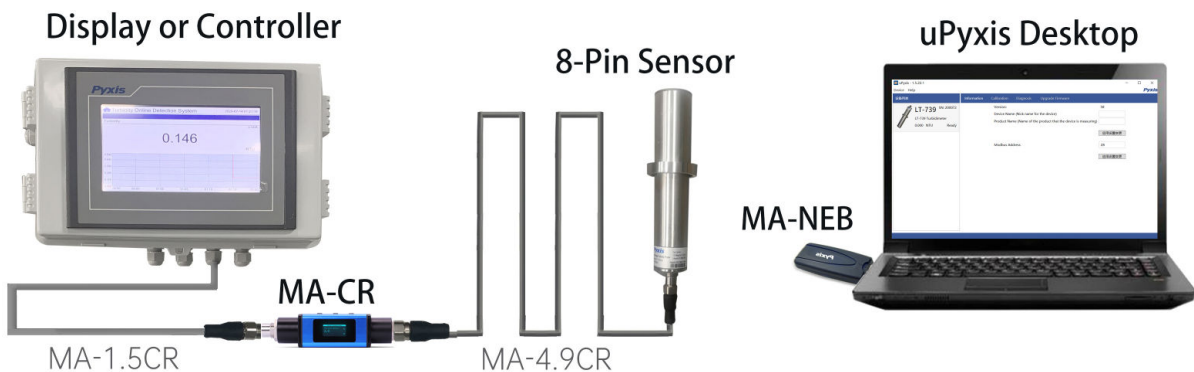

Figure 14. Bluetooth connection to LT-73X Series sensor with MA-CR, MA-NEB and uPyxis Desktop App.

## 6 Setup and Calibration with uPyxis® Desktop App

### 6.1 Install uPyxis® Desktop App

Download the latest version of **uPyxis®** Desktop software package from: <https://pyxis-lab.com/upyxis/> this setup package will download and install the Microsoft.Net Framework 4.5 (if not previously installed on the PC), the USB driver for the USB-Bluetooth adapter (MA-NEB), the USB-RS485 adapter (MA-485), and the main **uPyxis®** Desktop application. Double click the **uPyxis.Setup.exe** file to install.

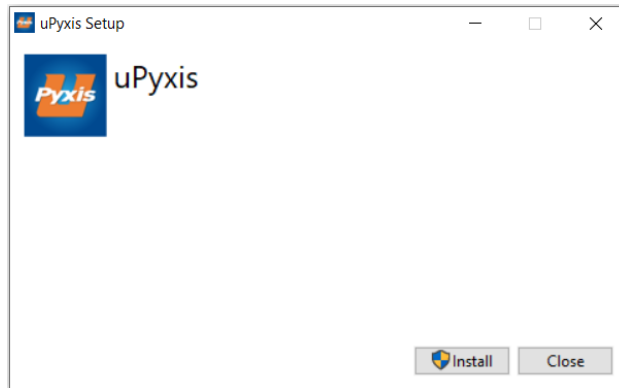

Figure 15. uPyxis® Desktop App installation

Click **Install** to start the installation process. Follow the screen instructions to complete the USB driver and uPyxis® installation.

## 6.2 Connecting to uPyxis® Desktop App

Connect the LT-73X Series sensor to a Windows computer using a Bluetooth/USB adapter (P/N: MA-NEB) according to the following steps:

1. Plug the Bluetooth/USB adapter into a USB port in the computer.
2. Launch uPyxis® Desktop App.
3. On uPyxis® Desktop App, click Device→ **Connect via USB-Bluetooth** (Figure 16).
4. If the connection is successful, the LT-73X Series and its Serial Number (SN) will be displayed in the left pane of the uPyxis® window.

**\*NOTE\*** After the sensor and Bluetooth is powered up, it may take up to 10 seconds for the adapter to establish the wireless signal for communication.

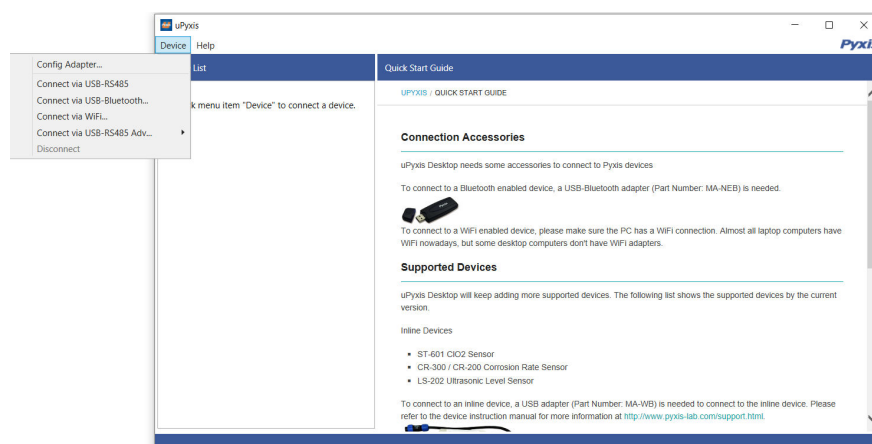

Figure 16.

### 6.3 Information Screen

Once connected to the device, a picture of the device will appear on the top-left corner of the window and the uPyxis® Desktop App will default to the **Information** screen. On the **Information** screen you can set the information description for **Device Name**, **Product Name**, and **Modbus Address**, then click **Apply Settings** to save.

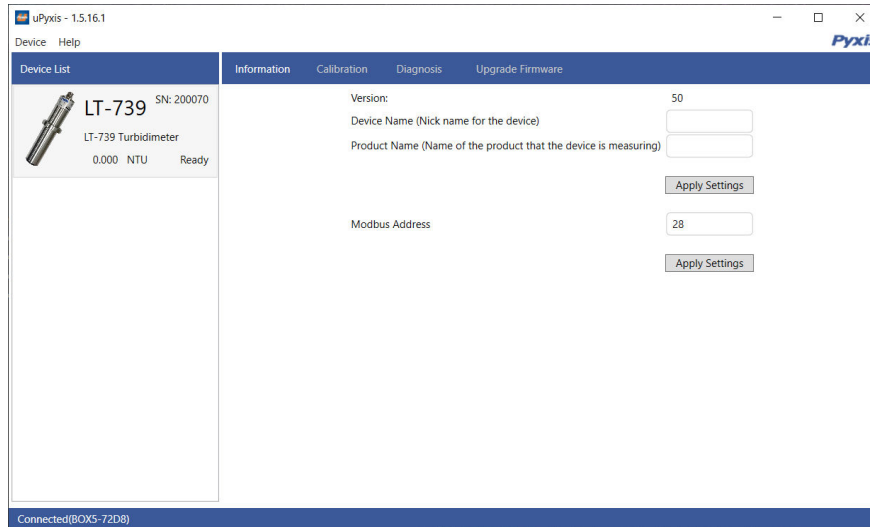

Figure 17.

### 6.4 Calibration Screen

To calibrate the device, click on **Calibration**. On the **Calibration** screen there are three calibration buttons, **Low Range Calibration**, **Mid Range Calibration**, **High Range Calibration**, and **4–20mA Span**. The screen also displays the reading of the device. The reading refresh rate is every 4 seconds. Please refer to the following table for the recommended turbidity standard solution for each range:

Table 8. Recommended Formazin Calibration Standards

Calibration Range	LT-736/LT-736B	LT-737/LT-737B	LT-739/LT-739B
Near Zero/Low	Bubble-free DI or sample <0.1 NTU		
Mid	5–50 NTU	1–2 NTU	5–10 NTU
High	500–1000 NTU	3–5 NTU	20–40 NTU

**\*NOTE\*** Calibration of the LT-73X Series sensor may be conducted in the flow vessel itself (FR-100 or FT-100) or by using the L-CAL Portable Liquid Formazin Calibration Kit (P/N: 53247). Please contact Pyxis Lab for details and procedures on the L-CAL Kit as an alternative to using inline vessel for calibration allowing dramatically reduced volume of Formazin solution required.

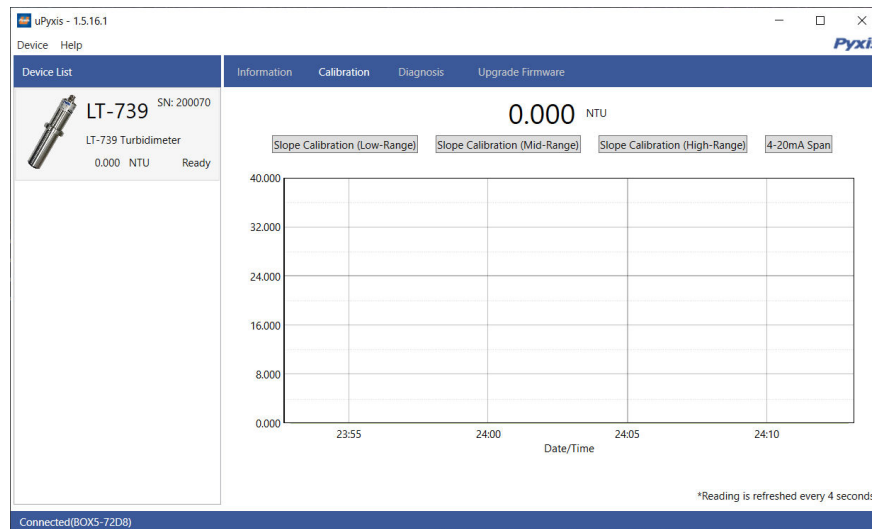

Figure 18.

### 6.4.1 Low Range Calibration

1. Empty the FR-100 Flow Reservoir or FT-100 Tee.
2. Wipe the FR-100 Flow Reservoir or FT-100 Tee walls and the LT-73X Series sensor surface with a dust-free cloth and confirm there are no obvious contaminants.
3. Fill the FR-100 Flow Reservoir or FT-100 Tee with deionized (DI) water.
4. Use a brush or the dust-free cloth to clean the FR-100 Flow Reservoir or FT-100 Tee walls and the LT-73X Series sensor surface.
5. Thoroughly drain the polluted DI water.
6. Repeat steps 3–5 three times to ensure optimum cleanliness.
7. Fill the FR-100 Flow Reservoir or FT-100 Tee with bubble-free DI water.
8. Allow the displayed data to stabilize; this could take some time to eliminate air bubbles.
9. Click **Low Range Calibration** to begin the low range calibration.
10. Enter "0.05" for the known turbidity value.

**\*NOTE\*** Because there is no global standard for zero turbidity in the industry, Pyxis recommends 0.05 NTU as a target low range calibration using bubble-free DI water. Users may vary from this entry value if desired, however, a true "zero" turbidity calibration standard does not exist.

11. If the calibration is successful, the interface will return a message "Calibration Succeeded". If the calibration has failed, the interface will return a message "Calibration Failed" and the user must repeat the process.



### 6.4.2 Mid Range Calibration

1. Conduct the Low Range Calibration steps above.
2. Empty the FR-100 Flow Reservoir or FT-100 Tee and refill with a known turbidity standard solution according to the **Recommended Formazin Calibration Standards** table.
3. Allow the displayed data to stabilize.
4. Click **Mid Range Calibration** to begin the middle range calibration.
5. Enter the known turbidity value.
6. If the calibration is successful, the interface will return a message "Calibration Succeeded". If the calibration has failed, the interface will return a message "Calibration Failed" and the user must repeat the process.

### 6.4.3 High Range Calibration

If the high range calibration is not required, the user does not need to calibrate the high range. To continue the high range calibration using a second turbidity standard solution, use the following steps:

1. Conduct the Mid Range Calibration steps above.
2. Empty the FR-100 Flow Reservoir or FT-100 Tee and refill with a known turbidity standard solution according to the **Recommended Formazin Calibration Standards** table.
3. Allow the displayed data to stabilize.
4. Click **High Range Calibration** to begin the middle range calibration.
5. Enter the known turbidity value.
6. If the calibration is successful, the interface will return a message "Calibration Succeeded". If the calibration has failed, the interface will return a message "Calibration Failed" and the user must repeat the process.

### 6.4.4 LT-SOLID-CAL Solid State Calibration

Alternatively, Pyxis Lab has developed reusable solid-state turbidity calibration kits for rapid calibration of the Pyxis LT-73X Series sensor. The LT-SOLID-CAL calibration kits represent an alternative to Formazin calibration for routine field calibration only. The Pyxis solid-state calibration kits provide a consistent and reproducible method to calibrate Pyxis LT-73X Series sensors, overcoming the challenges associated with the liquid standard calibration.

**Table 9.** T-CAL Calibration Kit Specifications for LT-73X Sensors

Specification	LT-SOLID-CAL 736	LT-SOLID-CAL 737	LT-SOLID-CAL 739
Part Number (P/N)	53229	53227	53228
Turbidities Included	0.10±0.05 NTU, 8.0±0.8 NTU, 25.0±2.5 NTU, 600±60 NTU	0.10±0.05 NTU, 1.5±0.15 NTU, 4.0±0.4 NTU	0.10±0.05 NTU, 8.0±0.8 NTU, 25.0±2.5 NTU

**Table 10.** LT-SOLID-CAL Calibration Kit Specifications for LT-73XB Sensors

Specification	LT-SOLID-CAL 736B	LT-SOLID-CAL 737B	LT-SOLID-CAL 739B
Part Number (P/N)	53239	53237	53238
Turbidities Included	0.10±0.05 NTU, 8.0±0.8 NTU, 25.0±2.5 NTU, 600±60 NTU	0.10±0.05 NTU, 1.5±0.15 NTU, 4.0±0.4 NTU	0.10±0.05 NTU, 8.0±0.8 NTU, 25.0±2.5 NTU

To calibrate the LT-73X Series sensor with the LT-SOLID-CAL kit, use the following steps:

1. Remove the LT-73X Series sensor from the FR-100 Flow Reservoir or FT-100 Tee.
2. Clean the LT-73X Series sensor surface gently with a soft towel.
3. Insert the LT-73X Series sensor into the appropriate T-CAL kit based on the **LT-SOLID-CAL Calibration Kit Specifications for LT-73X Sensors** and **LT-SOLID-CAL Calibration Kit Specifications for LT-73XB Sensors** tables.
4. Press either **Low Range Calibration**, **Mid Range Calibration**, or **High Range Calibration**.
5. Enter the designated NTU value assigned to the LT-SOLID-CAL kit for the known turbidity value.



**Figure 19.** LT-73X Series sensor use with LT-SOLID-CAL kit

## 6.5 Diagnosis Screen

After the device has been calibrated and installation has been completed, to check diagnosis, click on **Diagnosis**. When in the **Diagnosis** screen you can view the Diagnosis Condition of the device. This feature may be used for technical support when communicating with [service@pyxis-lab.com](mailto:service@pyxis-lab.com).

To perform a Cleanliness Check, first select the **Diagnosis Condition** which defines the fluid type that the LT-73X Series sensor is currently measuring, then click **Cleanliness Check**. If the sensor is clean, a green **Clean** message will be shown. If the sensor is severely fouled, a red **Dirty** message will be shown. In this case, follow the procedure in the **Methods to Cleaning the LT-73X Series Sensor** section of this manual.

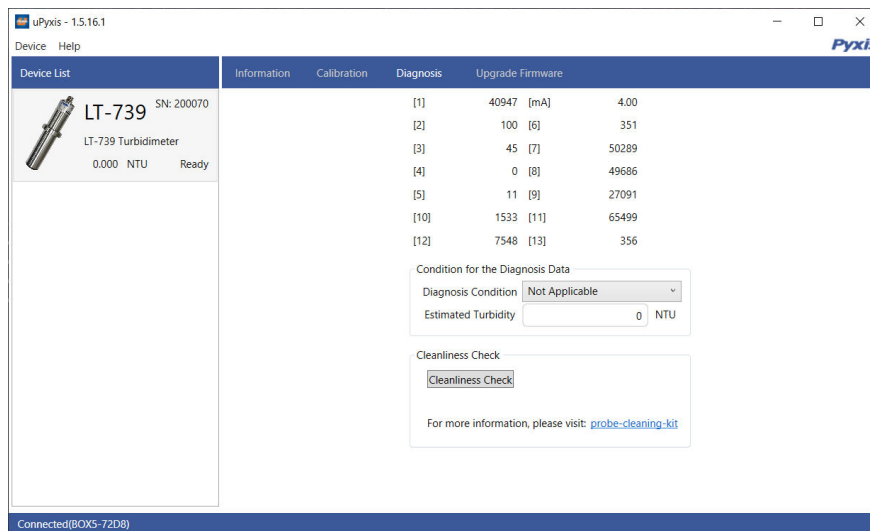

Figure 20.

## 7 Outputs

### 7.1 4–20mA Output Setup

The 4–20mA output of the LT-736 and LT-736B sensor is scaled as:

- Turbidity:
  - 4 mA = 0 NTU
  - 20 mA = 1000 NTU

The 4–20mA output of the LT-737 and LT-737B sensor is scaled as:

- Turbidity:
  - 4 mA = 0 NTU
  - 20 mA = 5 NTU

The 4–20mA output of the LT-739 and LT-739B sensor is scaled as:

- Turbidity:
  - 4 mA = 0 NTU
  - 20 mA = 40 NTU

## 7.2 Adjusting 4–20mA Span

Users may adjust the output scale using 4–20mA Span to change the turbidity NTU value corresponding to the 20 mA output via uPyxis®. For the uPyxis® Mobile App, press **4-20mA Span** found on the **Calibration and Reading Screen**, shown in Figure 21. For the uPyxis® Desktop App, click **4-20mA Span** found on the **Calibration Screen**, shown in Figure 22.

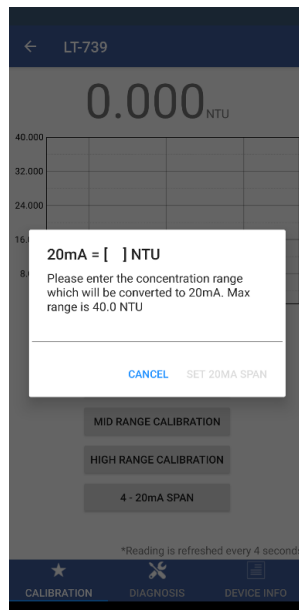

Figure 21.

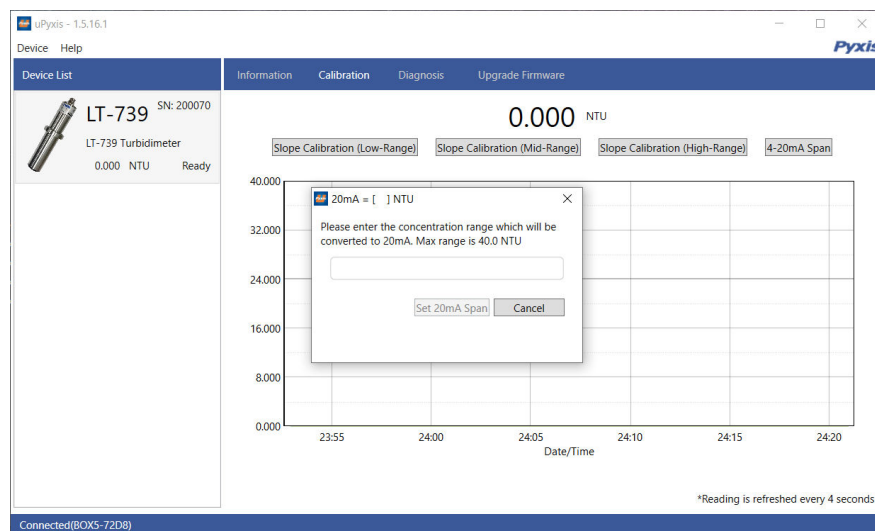

Figure 22.

## 7.3 Communication using Modbus RTU

The LT-73X Series sensor is configured as a Modbus slave device. In addition to the turbidity NTU value, many operational parameters, including warning and error messages, are available via a Modbus RTU connection. Contact Pyxis Lab Customer Service ([service@pyxis-lab.com](mailto:service@pyxis-lab.com)) for more information.

## 8 Sensor Maintenance and Precaution

The LT-73X Series sensor is designed to provide reliable and continuous turbidity readings even when installed in moderately contaminated industrial cooling waters. Although the optics are compensated for the effects of moderate fouling, heavy fouling will prevent the light from reaching the sensor, resulting in low readings and the potential for product overfeed if the LT-73X Series sensor is used as part of an automated control system. When used to control product dosing, it is suggested that the automation system be configured to provide backup to limit potential product overfeed, for example by limiting pump size or duration, or by alarming if the pumping rate exceeds a desired maximum limit.

The LT-73X Series sensor is designed to be easily removed, inspected, and cleaned if required. It is suggested that the LT-73X Series sensor be checked for fouling and cleaned/calibrated on a monthly basis. Heavily contaminated waters may require more frequent cleanings. Cleaner water sources with less contamination may not require cleaning for several months.

The need to clean the LT-73X Series sensor can be determined by the **Cleanliness Check** using either the **uPyxis®** Mobile App (see the **Mobile Diagnosis Screen** section) or the **uPyxis®** Desktop App (see the **Desktop Diagnosis Screen** section).

### 8.1 Methods to Cleaning the LT-73X Series Sensor

Any equipment in contact with industrial cooling systems is subject to many potential foulants and contaminants. Our inline sensor cleaning solutions below have been shown to remove most common foulants and contaminants. A small, soft bristle brush, Q-Tips cotton swab, or soft cloth may be used to safely clean the sensor housing and the quartz optical sensor channel. These components and more come with a Pyxis Lab **Inline Probe Cleaning Solution Kit** (P/N: SER-01) which can be purchased at our online E-Store <https://pyxis-lab.com/product/st-series-probe-cleaning-kit/>



Figure 23. Inline Probe Cleaning Solution Kit

To clean the LT-73X Series sensor, soak the lower half of the sensor in 100 mL inline sensor cleaning solution for 15 minutes. Rinse the LT-73X Series sensor with distilled water and then check for the flashing blue light inside the LT-73X Series sensor quartz tube. If the surface is not entirely clean, continue to soak the LT-73X Series sensor for an additional 15 minutes. Use the small, soft bristle brush and Q-Tips cotton swabs as necessary to remove any remaining contaminants in the LT-73X Series sensor quartz tube.

## **8.2 Storage**

Avoid long term storage at temperature over 100 °F. In an outdoor installation, properly shield the LT-73X Series sensor from direct sunlight and precipitation.

## **9 Troubleshooting**

If the LT-73X Series sensor output signal is not stable and fluctuates significantly, make an additional ground connection — connect the black (shield) wire to a conductor that contacts the sample water electrically such as a metal pipe adjacent to the LT-73X Series tee.

## **10 Contact Us**

**Pyxis Lab, Inc**

1729 Majestic Dr. Suite 5

Lafayette, CO 80026 USA

[www.pyxis-lab.com](http://www.pyxis-lab.com)

Phone: +1 (866) 203-8397

Email: [service@pyxis-lab.com](mailto:service@pyxis-lab.com)